



COMUNE DI AREZZO

Assessorato Urbanistica

Servizio Pianificazione Urbanistica e Governo del Territorio

Piano Strutturale
2019



PS
PS

B Quadro conoscitivo

B1 Relazione illustrativa - Indagini geologiche e idrauliche

Sindaco
Alessandro Ghinelli

Assessore all'Urbanistica
Marco Sacchetti

Responsabile del Procedimento
Ing. Paolo Frescucci

RTI Raggruppamento Temporaneo di Professionisti

Studio D:RH Architetti associati

Arch. Sergio Dinale

Criteria srl

Arch. Paolo Falqui

Arch. Luca Di Figlia

Dott. Pian.t. Matteo Scamporrino

Avv. Agostino Zanelli Quarantini

B1.2.1f

Settore Sud2 - Fascicolo delle sezioni e profili idraulici

Garante dell'informazione e della partecipazione

Dott.ssa Daniela Farsetti

Dirigente Servizio Pianificazione Urbanistica
Ing. Paolo Frescucci

Dirigente Servizio Ambiente
Ing. Giovanni Baldini

Dirigente Servizio Progettazione Opere Pubbliche
Ing. Antonella Fabbianelli

Dirigente Progetto per lo sviluppo delle attività economiche negli ambiti Edilizia e SUAP e promozione del territorio
Ing. Paolo Frescucci

Direttore Ufficio Mobilità
Ing. Roberto Bernardini

Direttore Ufficio Programmazione e Sviluppo Economico del Territorio
Dott.ssa Stefania Guidelli

Direttore Ufficio Edilizia
Geom. Gianna Pezuoli

Ufficio del Piano

Arch. Omero Angeli
Dott.ssa Antonella Benocci
Sig. Matteo Borri
Dott.ssa Francesca Calabri
Arch. Fulvia Comanducci
Arch. Elisabetta Dreassi
Geol. Alessandro Forzoni
Geom. Valentina Mazzoni
Dott. Vincenzo Oliva
Arch. Laura Pagliai
Ing. Deborah Romei
Arch. Laura Rogialli
Geol. Annalisa Romizi
Pianificatore Territoriale Lorenzo Spadaccini
Sig.ra Fiorenza Verdelli

Gruppo di progettazione

Studio D:RH Architetti associati

Arch. Sergio Dinale
Arch. Paola Rigonat Hugues
Arch. Enrico Robazza
Arch. Kristiana D'Agnolo
Dott. Pian.t. Giulio Brocco

Criteria srl

Arch. Paolo Falqui
Ing. Paolo Bagliani
Ing. Roberto Ledda
Biol. Patrizia Carla Sechi
Geol. Andrea Soriga
Arch. Laura Zanini
Dott.ssa Giulia Cubadda
Dott. Riccardo Frau
Arch. Veronica Saddi
Ing. Gianfilippo Serra
Dott. Vittorio Serra
Dott.ssa Cinzia Marcella Orrù
Arch. Salvatore Manca

Indagini geologiche e idrauliche

Geol. Maurizio Costa
Geol. Antonio Pitzalis
Ing. Nicola Buchignani (Prima STP)
Ing. Pietro Chiavaccini
Ing. Elisa Formica

Dott. Pian.t. Matteo Scamporrino
Arch Luca Di Figlia
Avv. Agostino Zanelli Quarantini

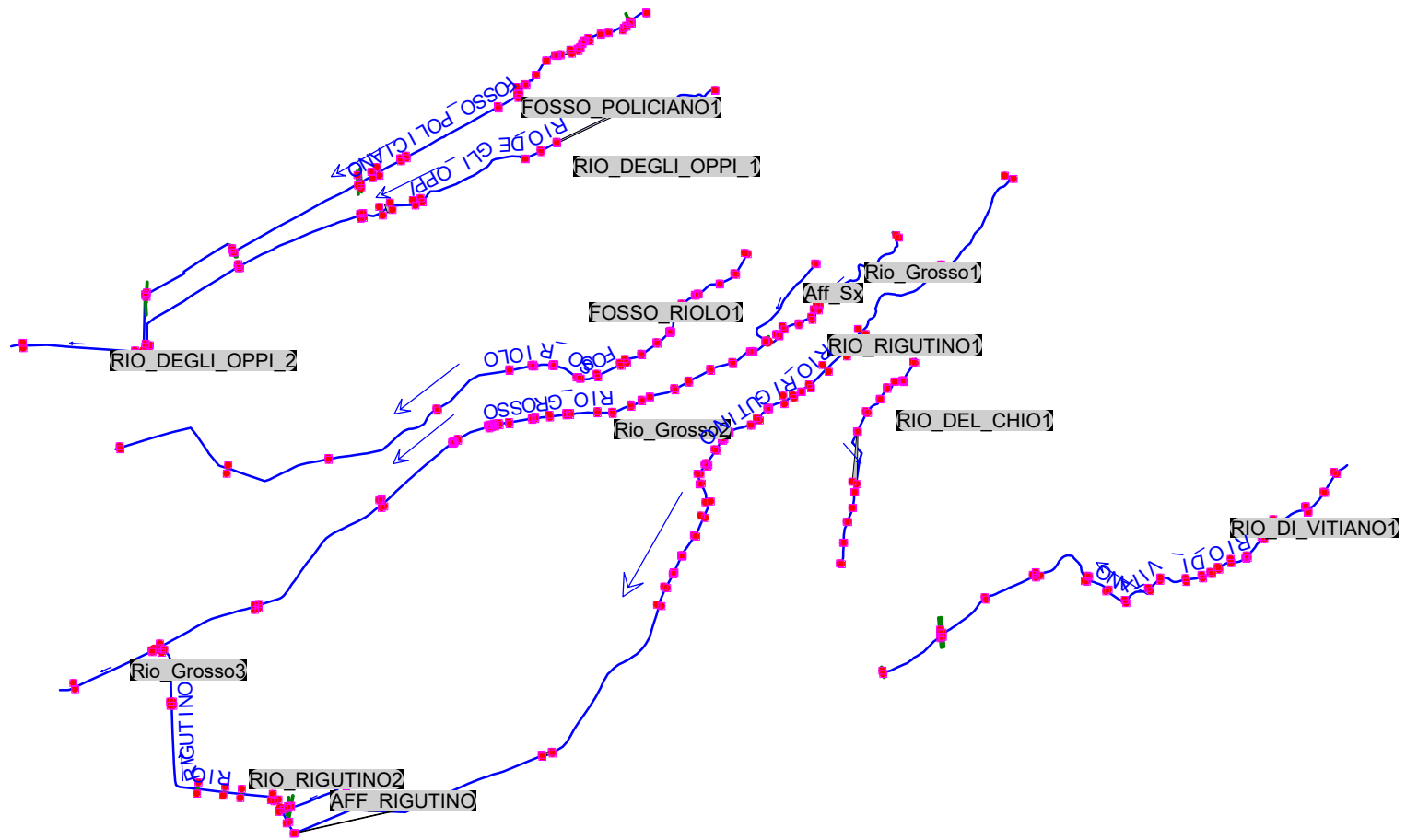

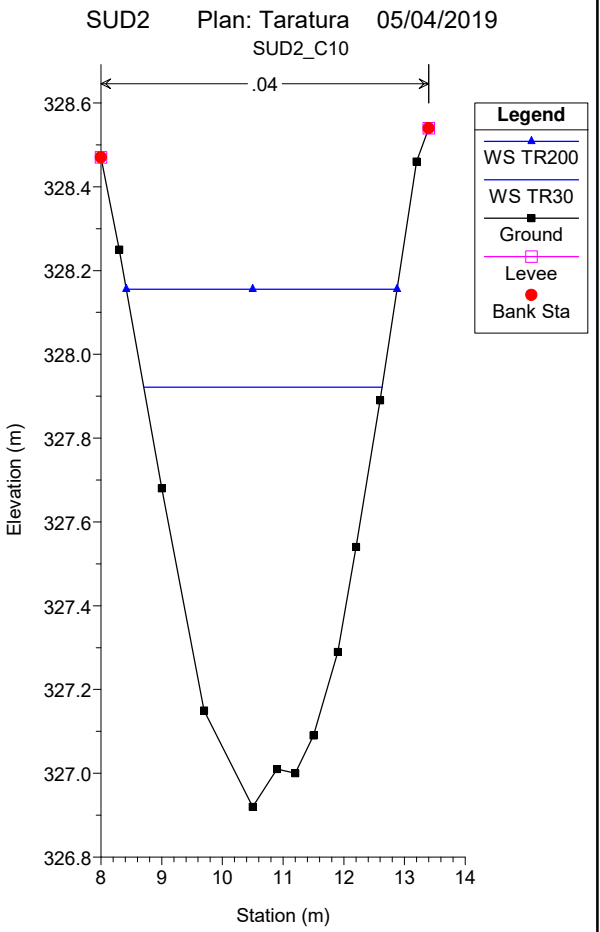
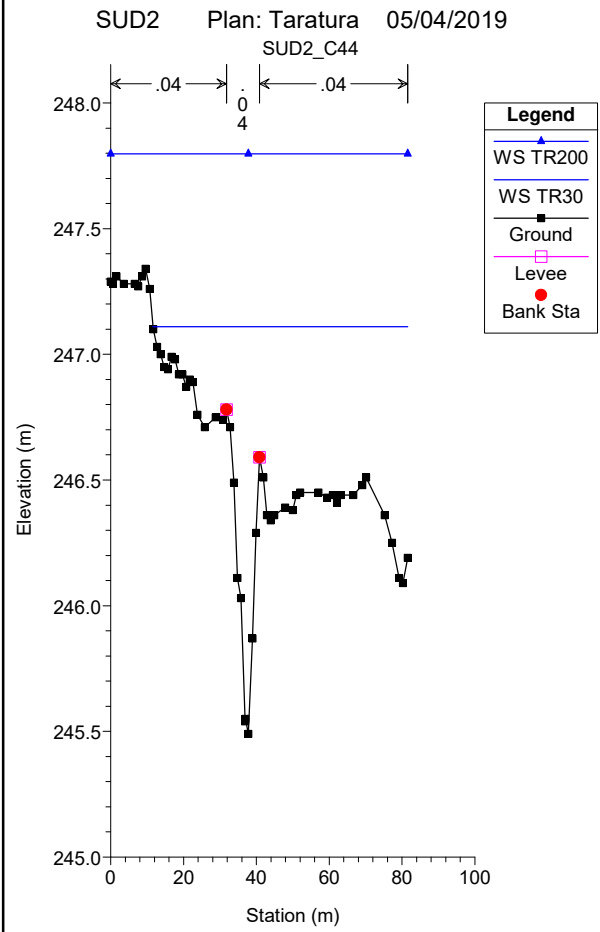
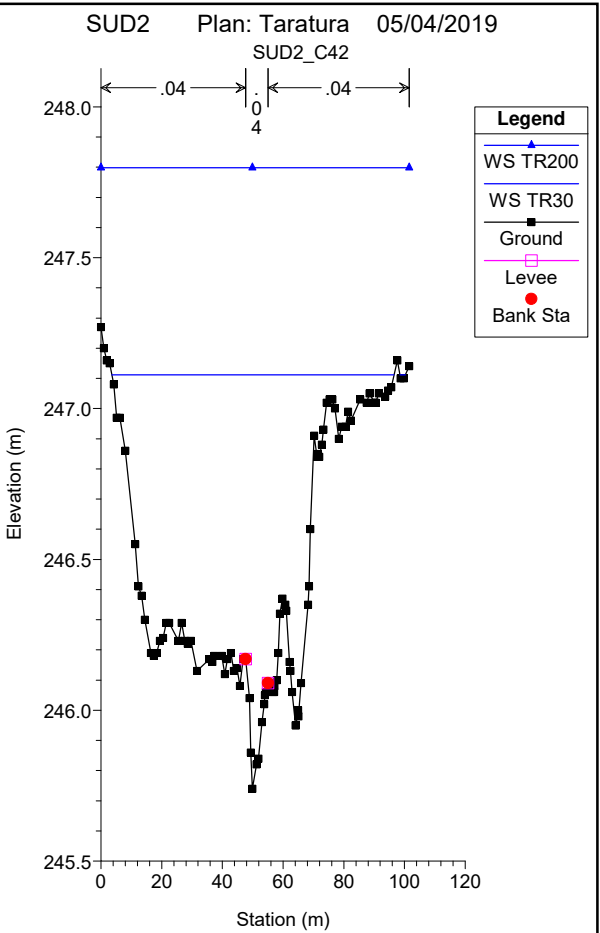
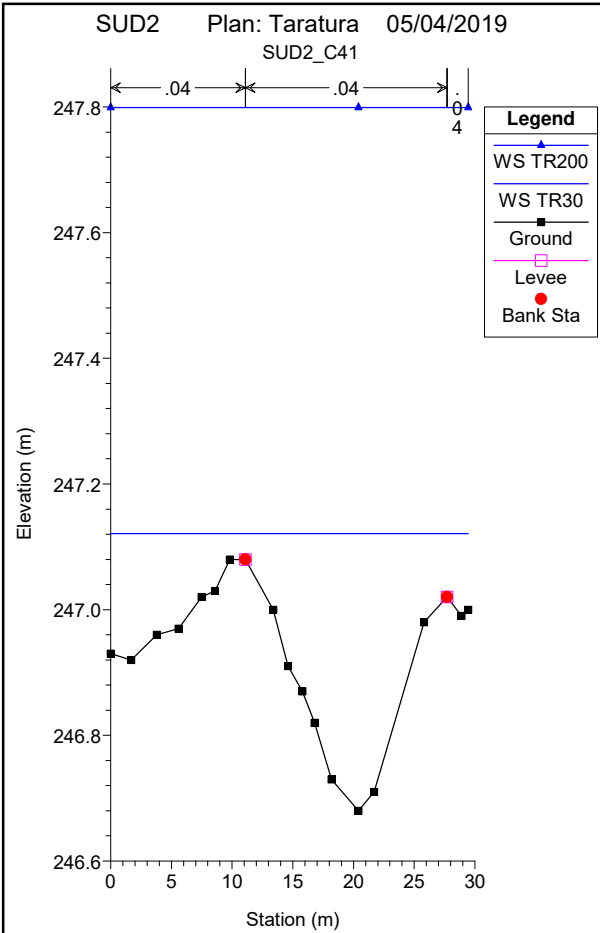

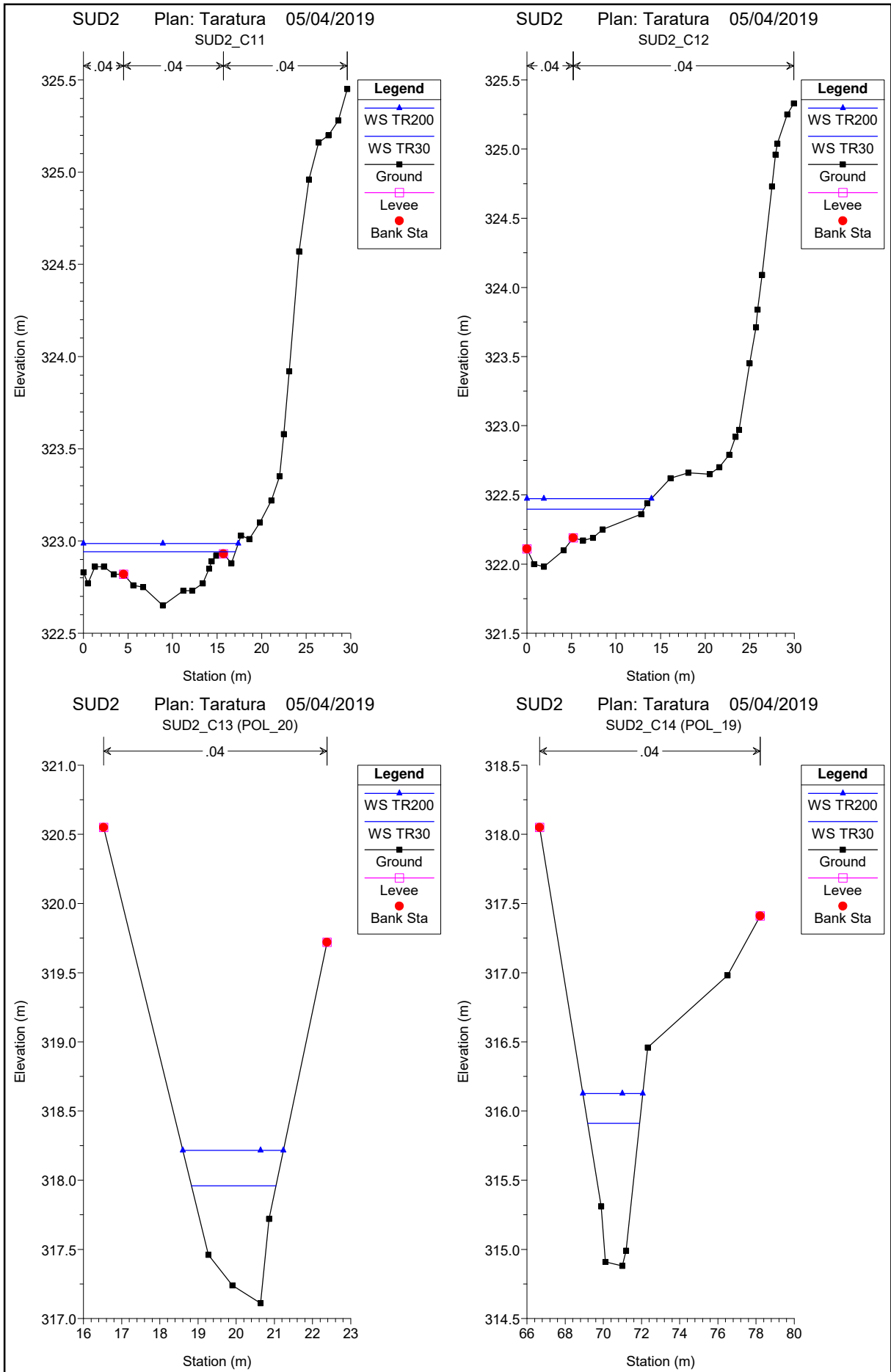

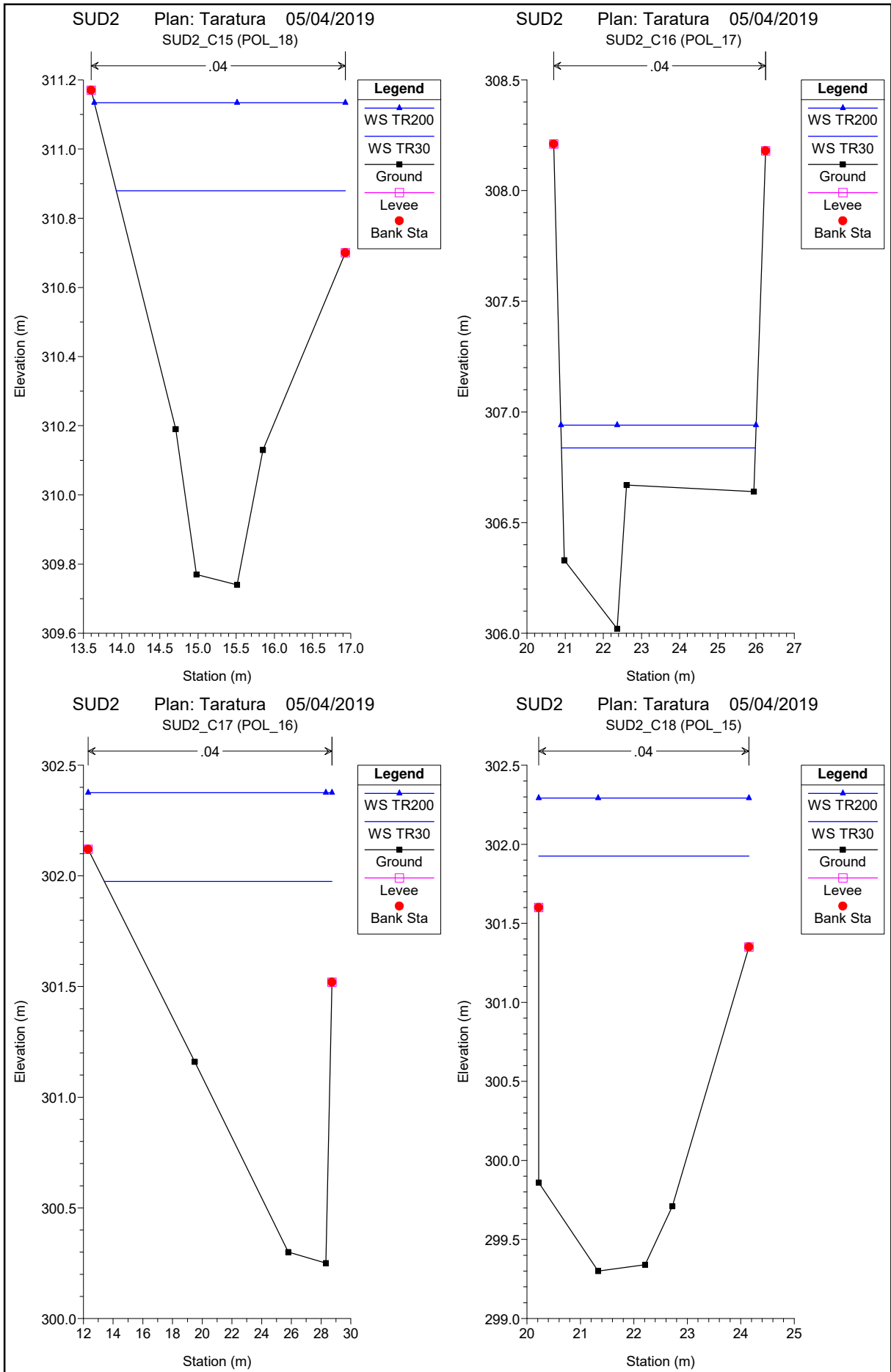

SUD2 Plan: Taratura 05/04/2019

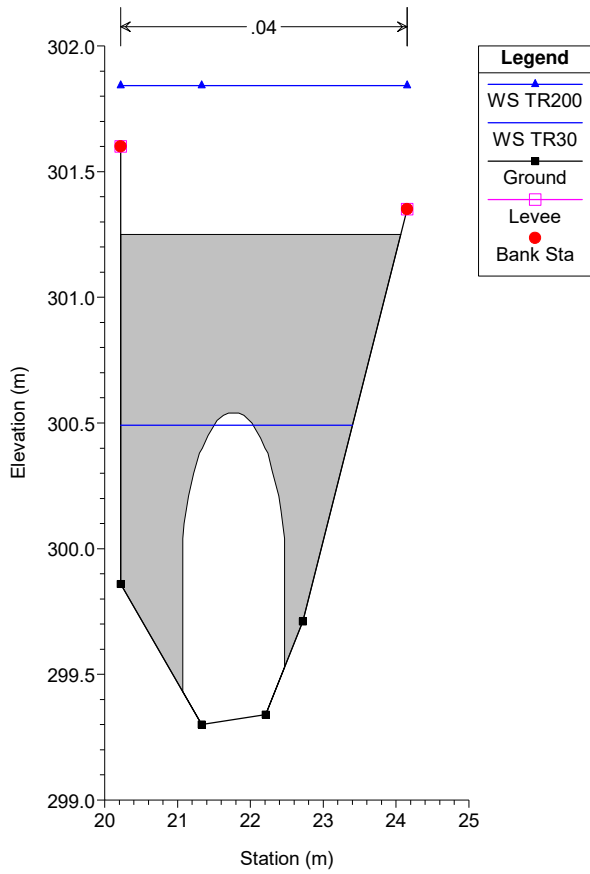

SUD2 Plan: Taratura 05/04/2019

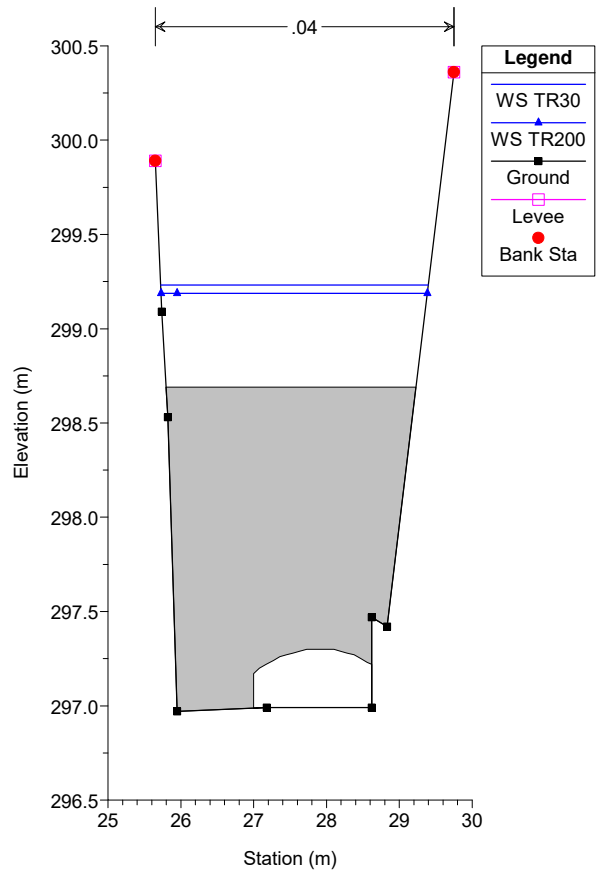

SUD2 Plan: Taratura 05/04/2019
SUD2_C19 (POL_14)

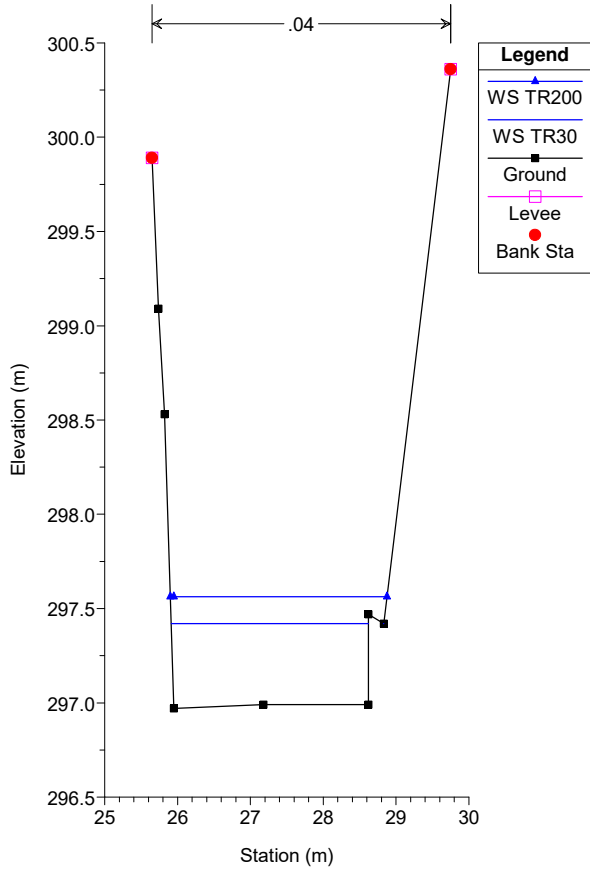

SUD2 Plan: Taratura 05/04/2019
SUD2_C20 (POL_13)

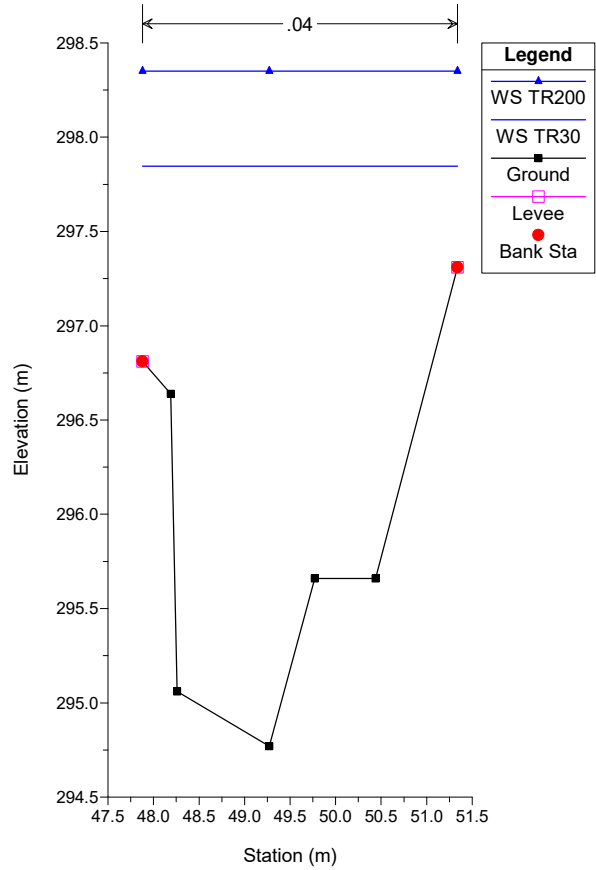

SUD2 Plan: Taratura 05/04/2019

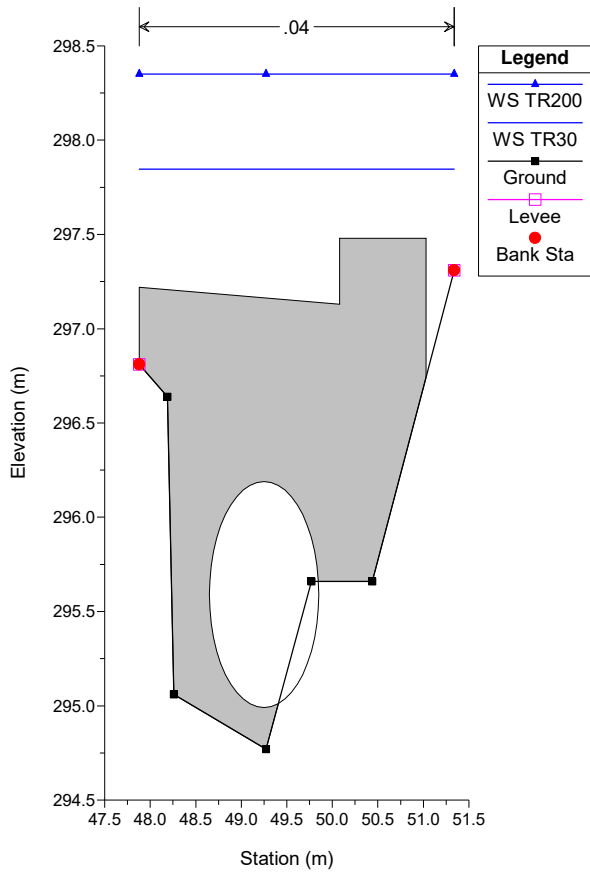

SUD2 Plan: Taratura 05/04/2019

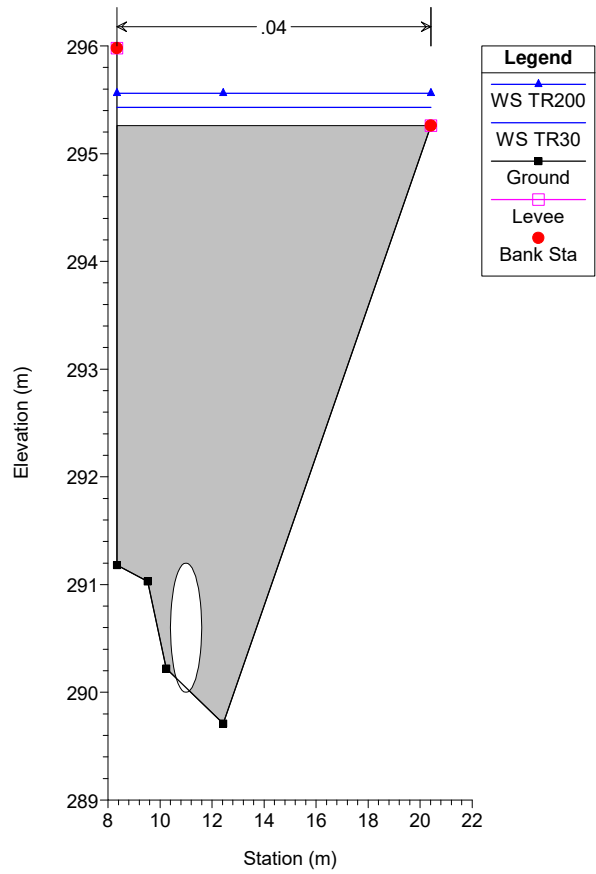

SUD2 Plan: Taratura 05/04/2019
SUD2_C21 (POL_11)

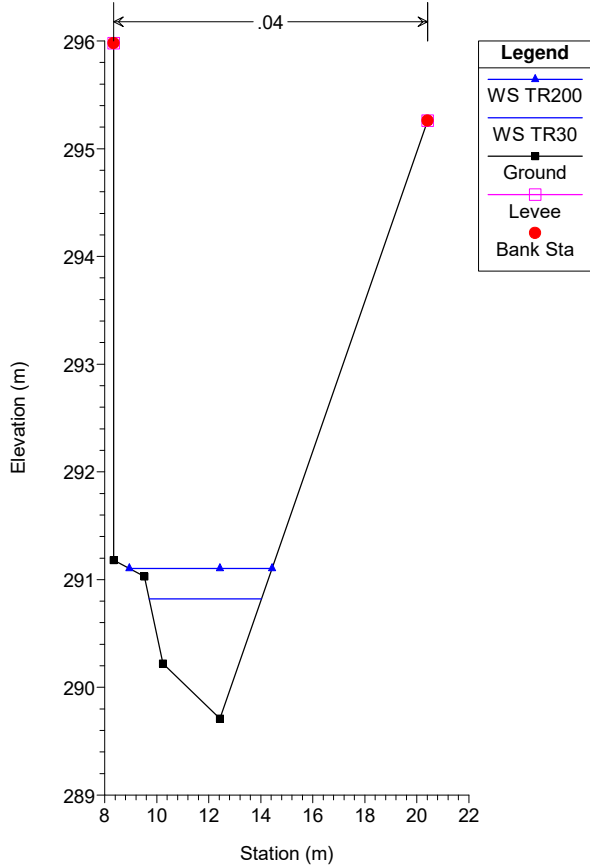

SUD2 Plan: Taratura 05/04/2019
SUD2_C22 (POL_10)

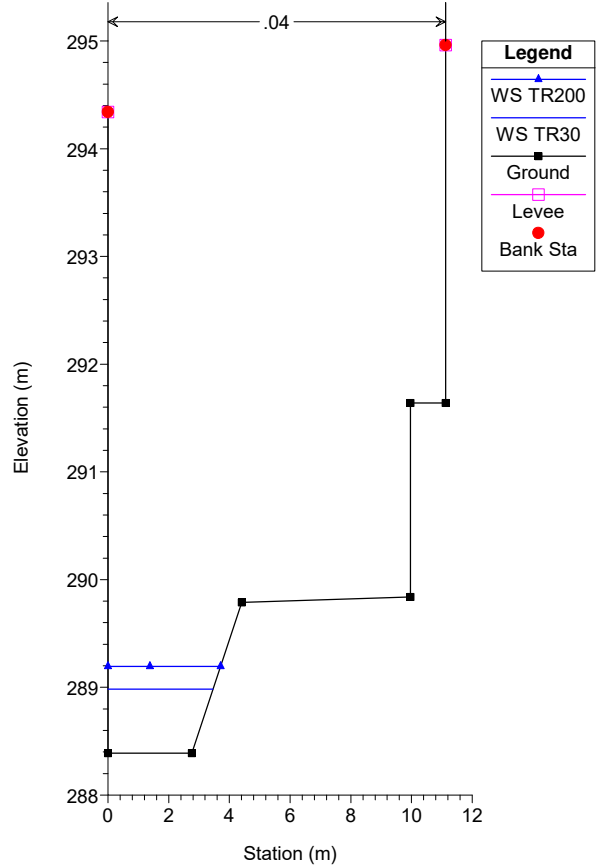

SUD2 Plan: Taratura 05/04/2019

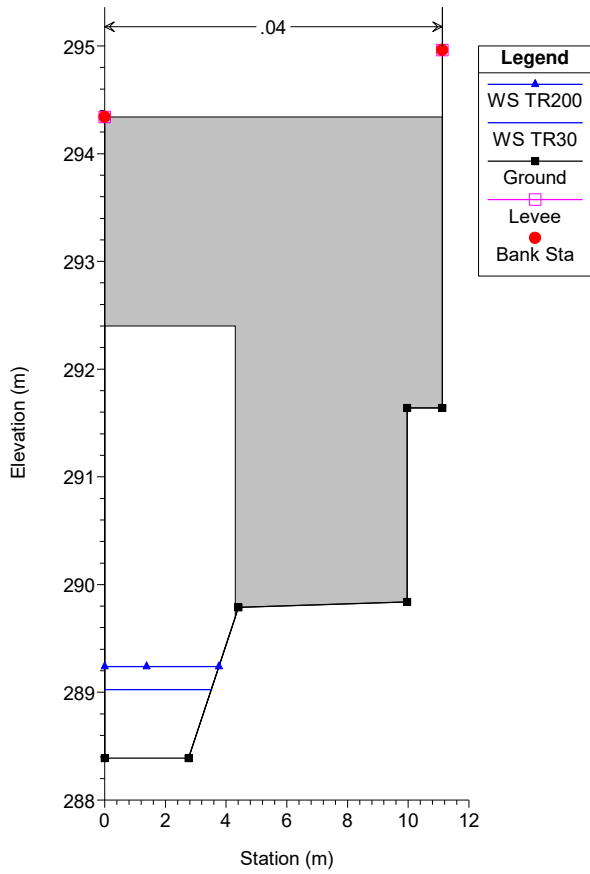

SUD2 Plan: Taratura 05/04/2019

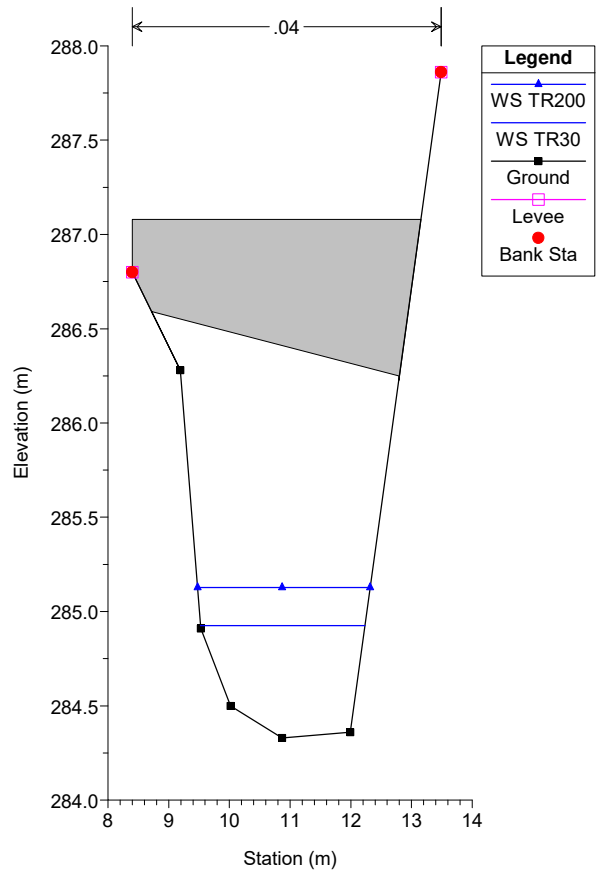

SUD2 Plan: Taratura 05/04/2019
SUD2_C23 (POL_09)

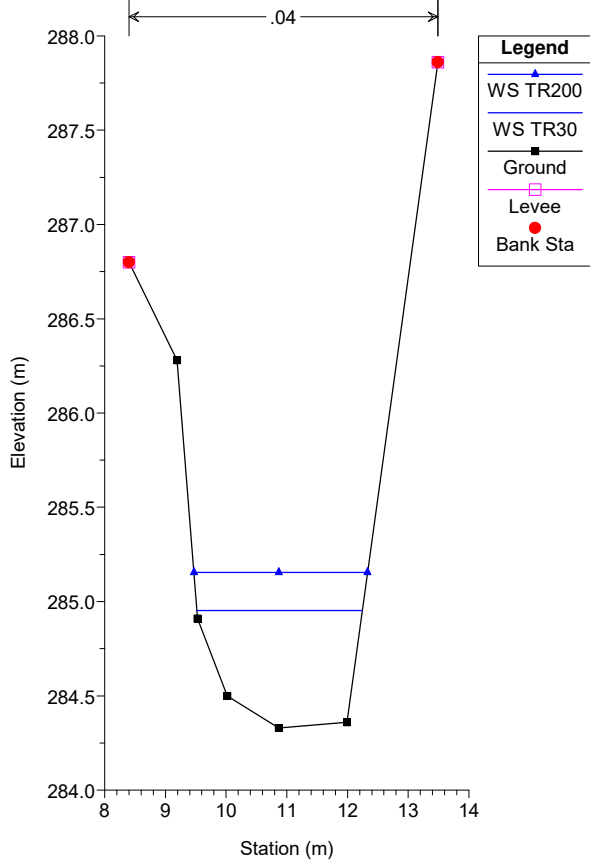

SUD2 Plan: Taratura 05/04/2019
SUD2_C24 (POL_08)

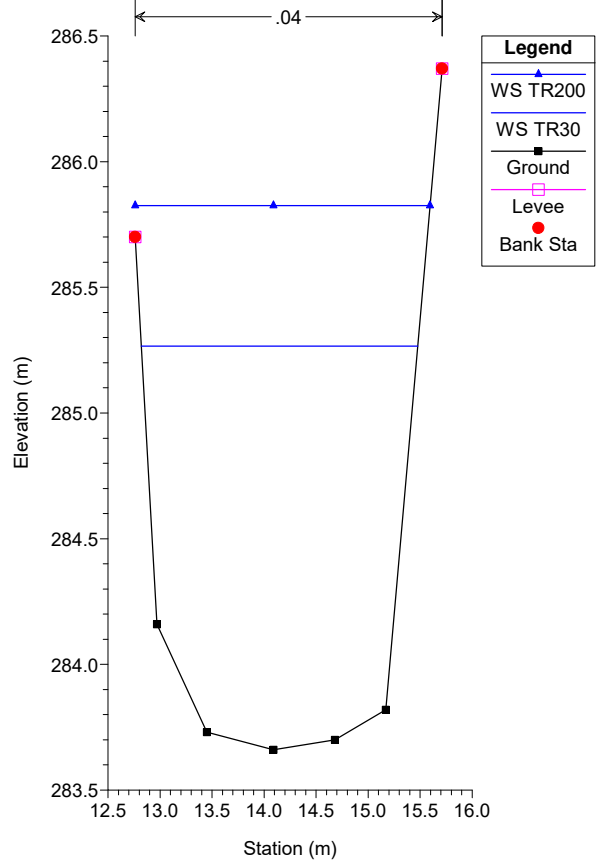

SUD2 Plan: Taratura 05/04/2019

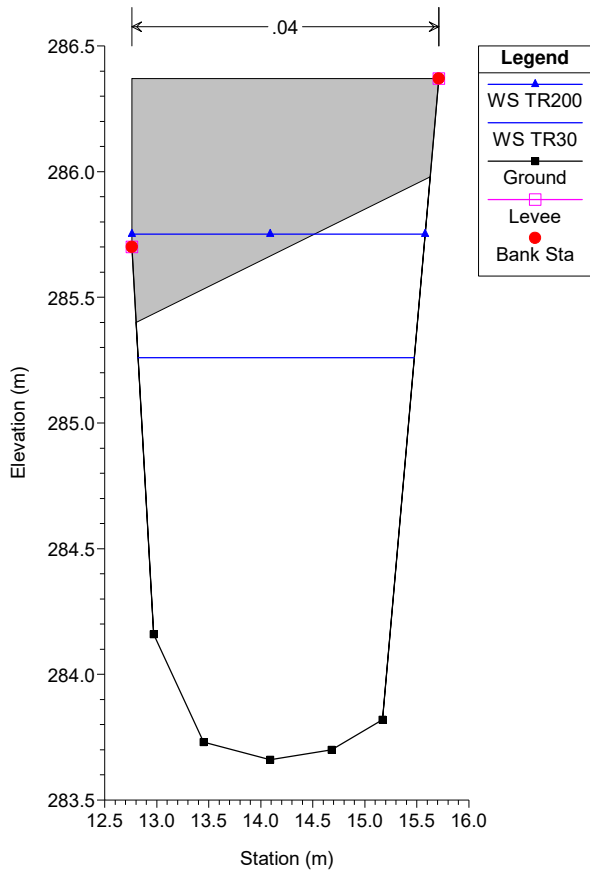

SUD2 Plan: Taratura 05/04/2019

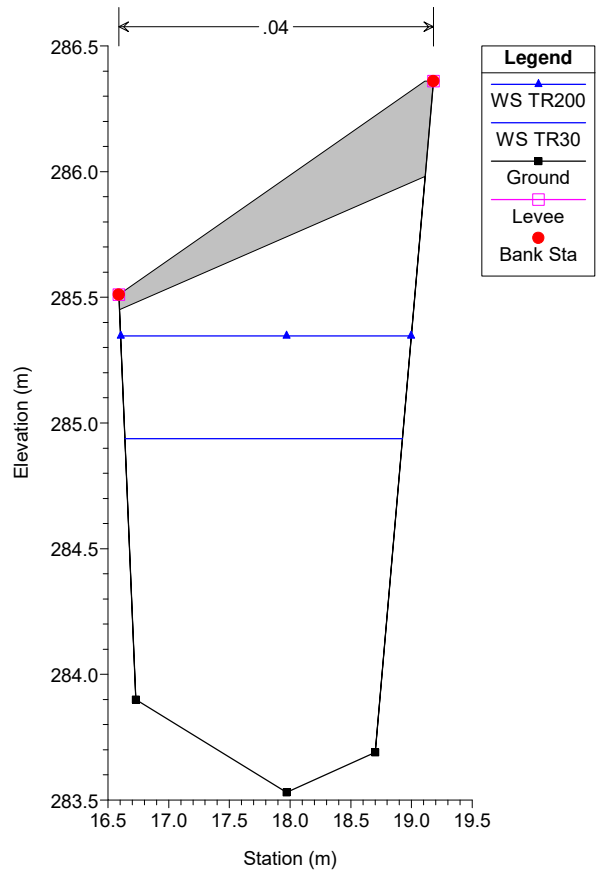

SUD2 Plan: Taratura 05/04/2019
SUD2_C25 (POL_07)

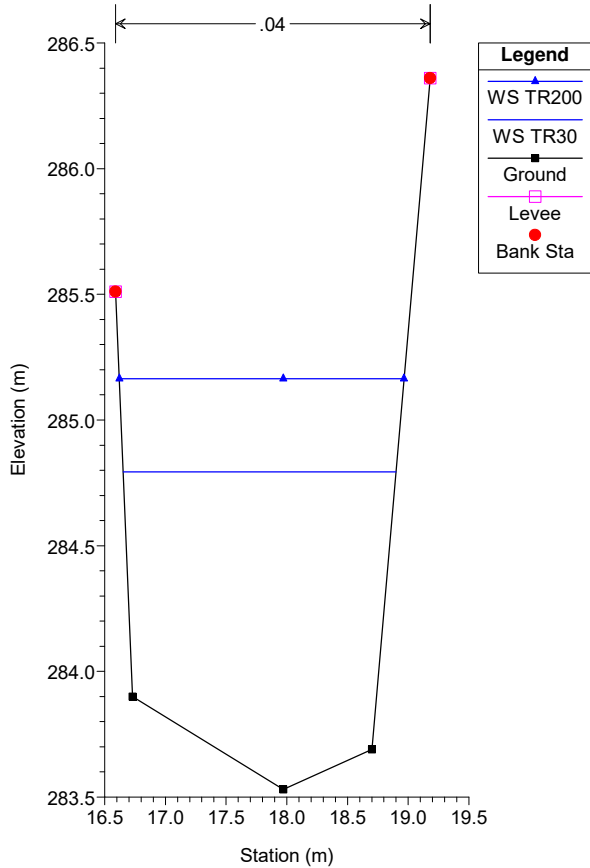

SUD2 Plan: Taratura 05/04/2019
SUD2_C26 (POL_06)

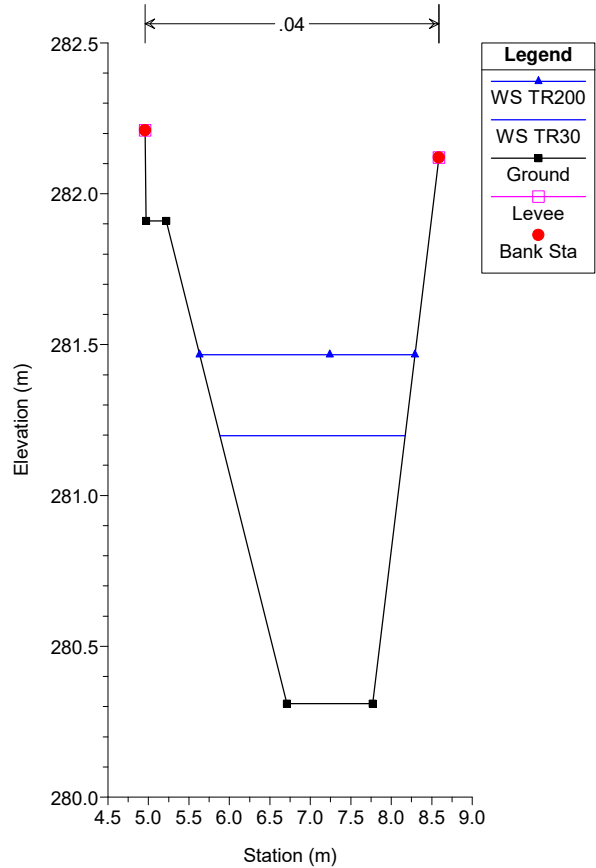

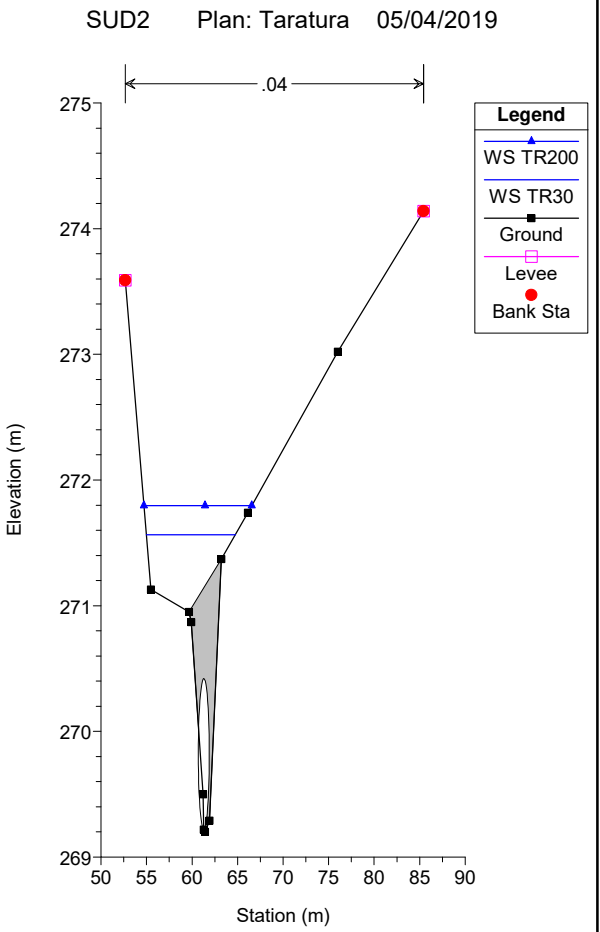
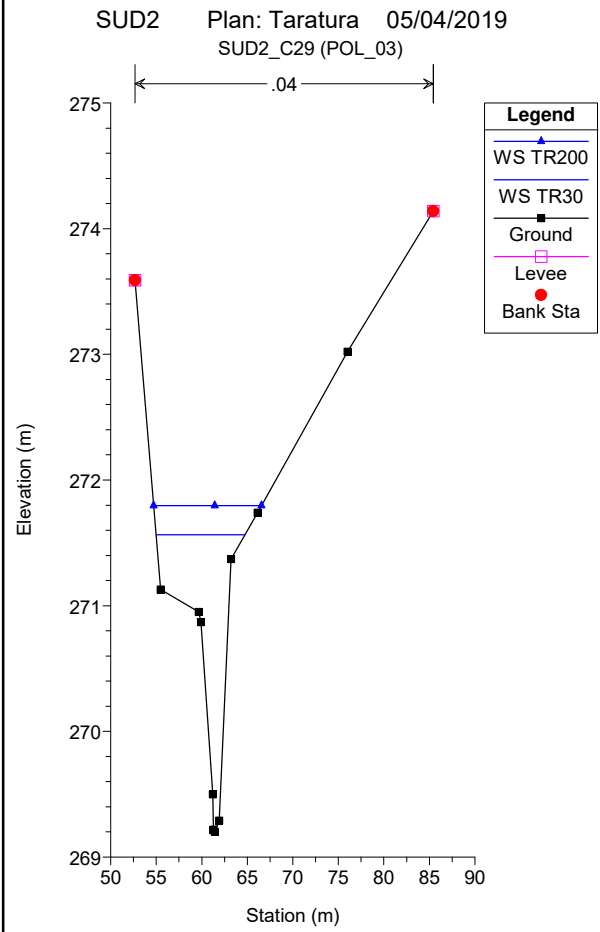
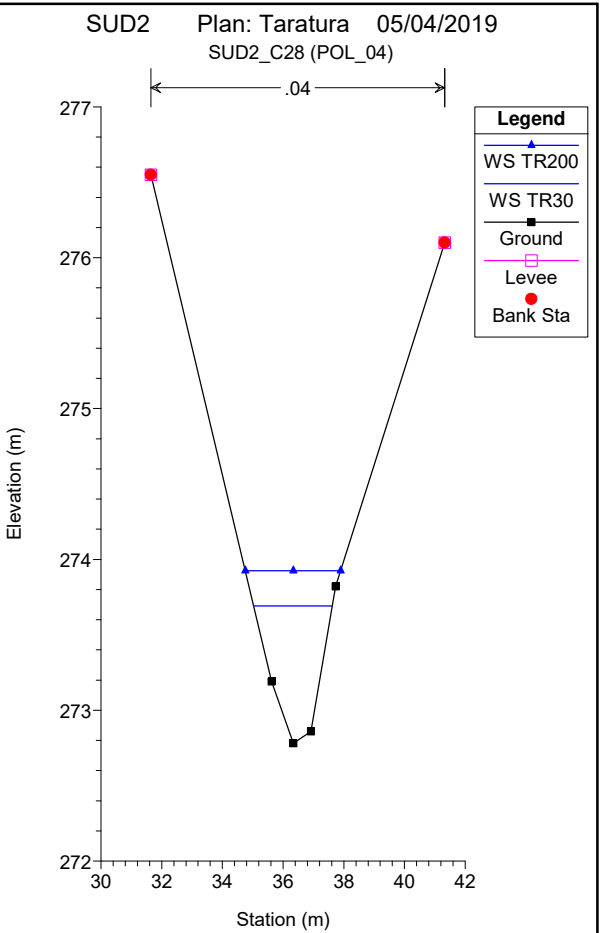
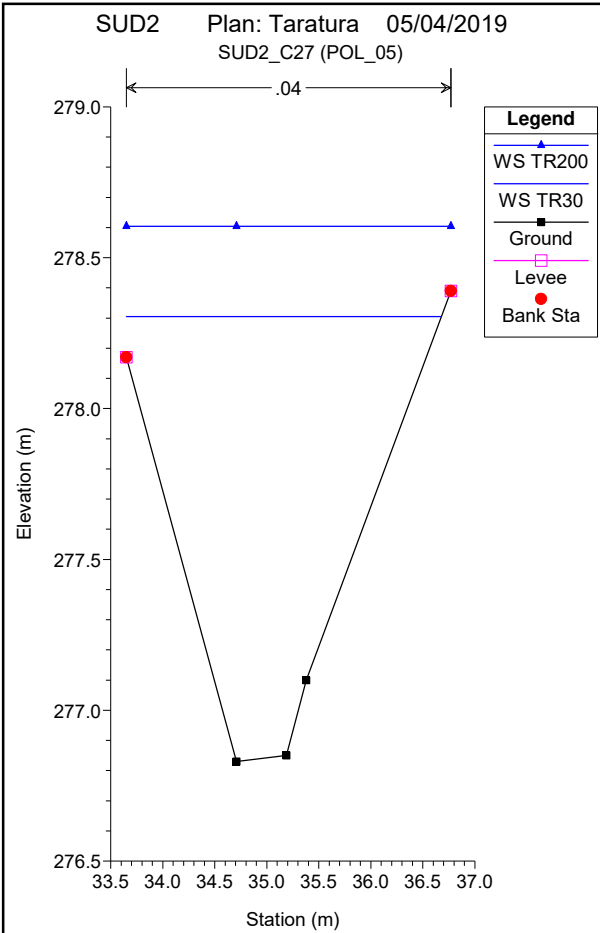

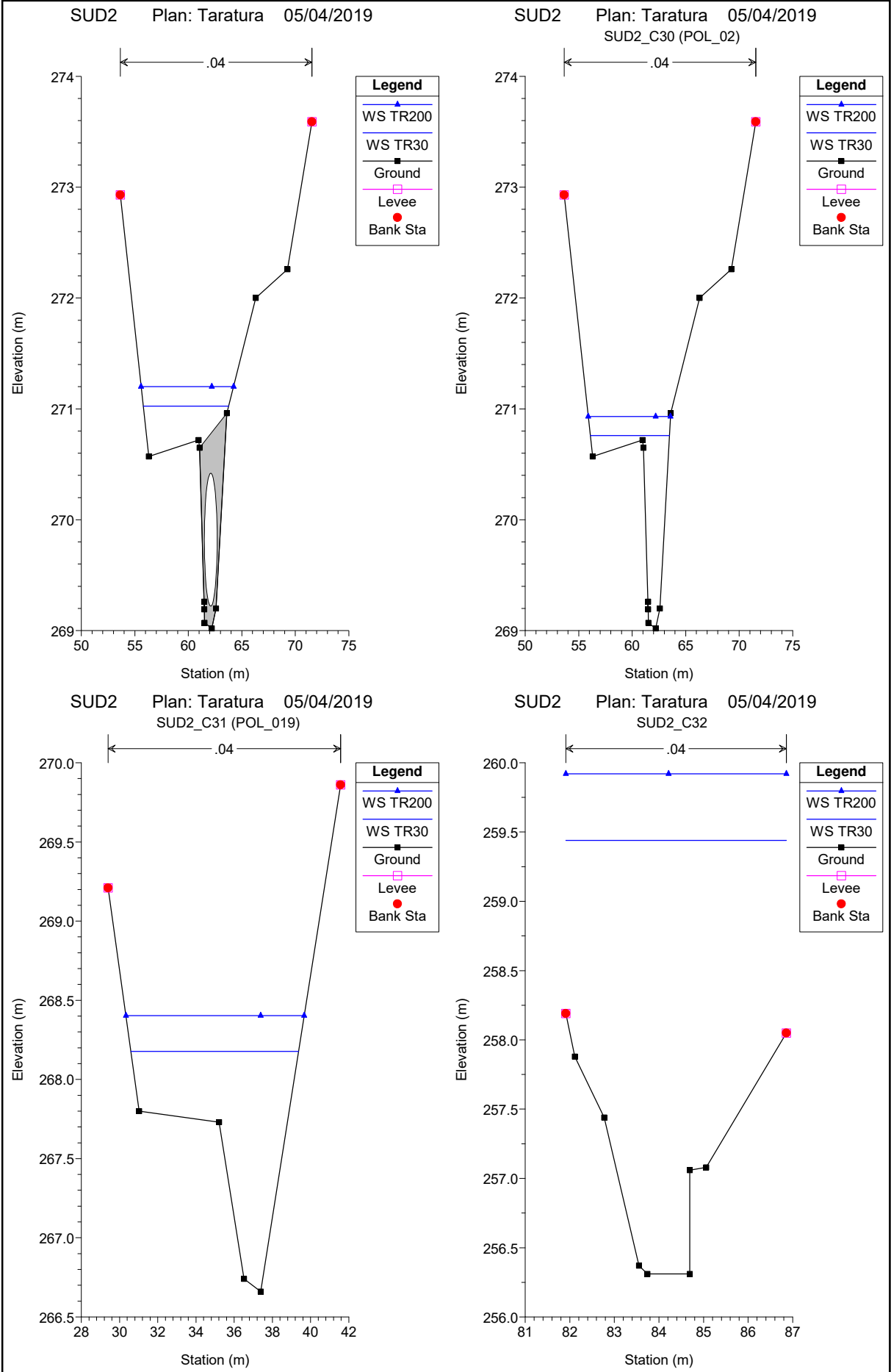

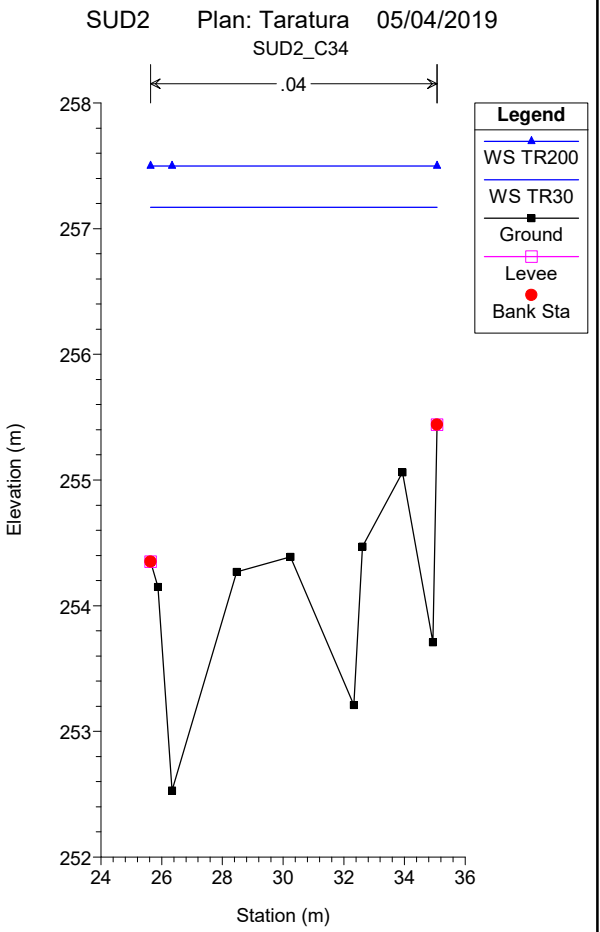
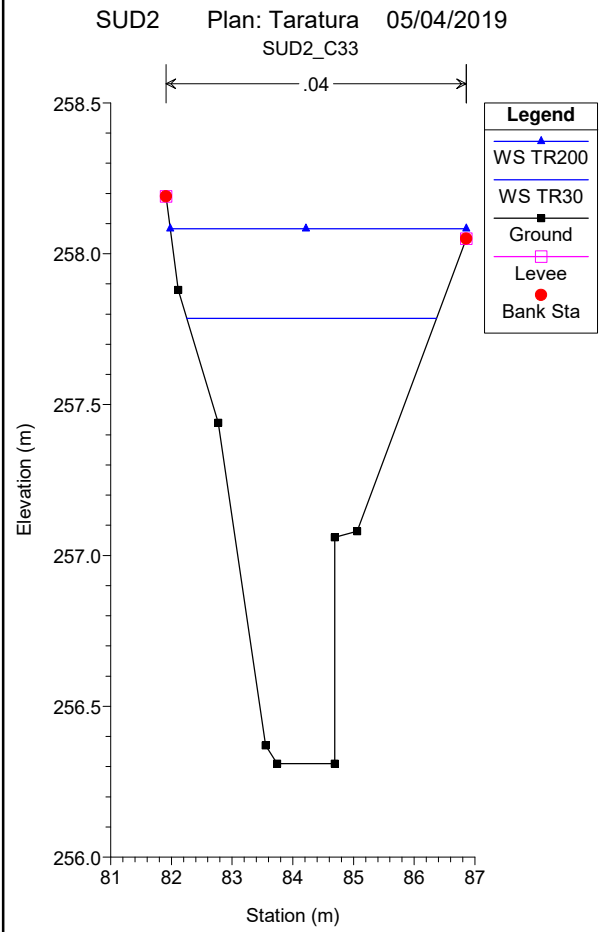
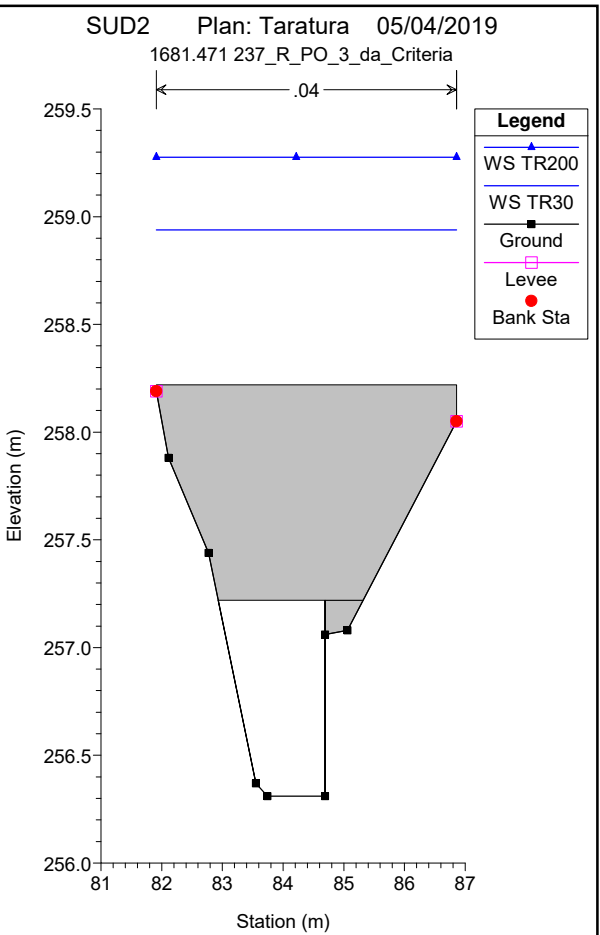
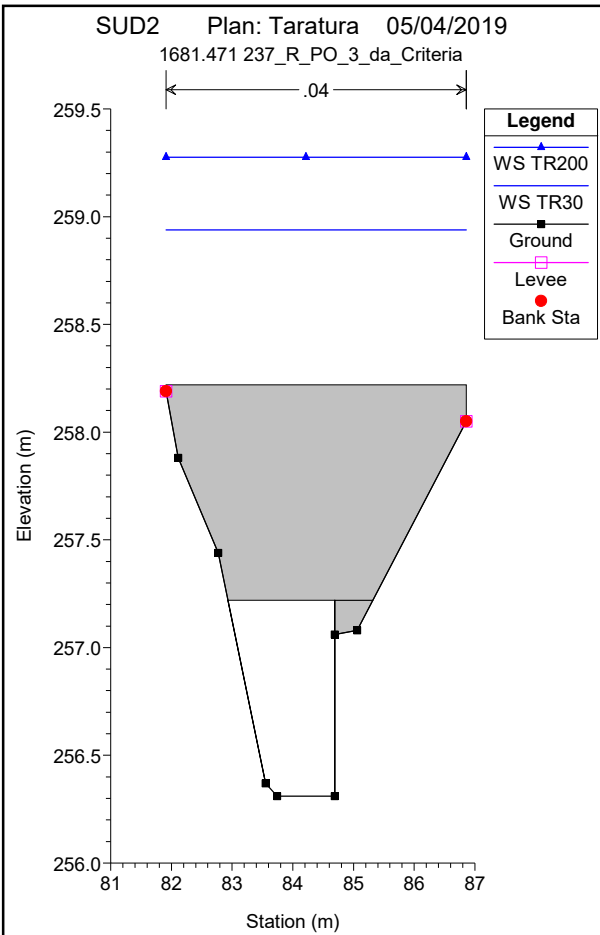

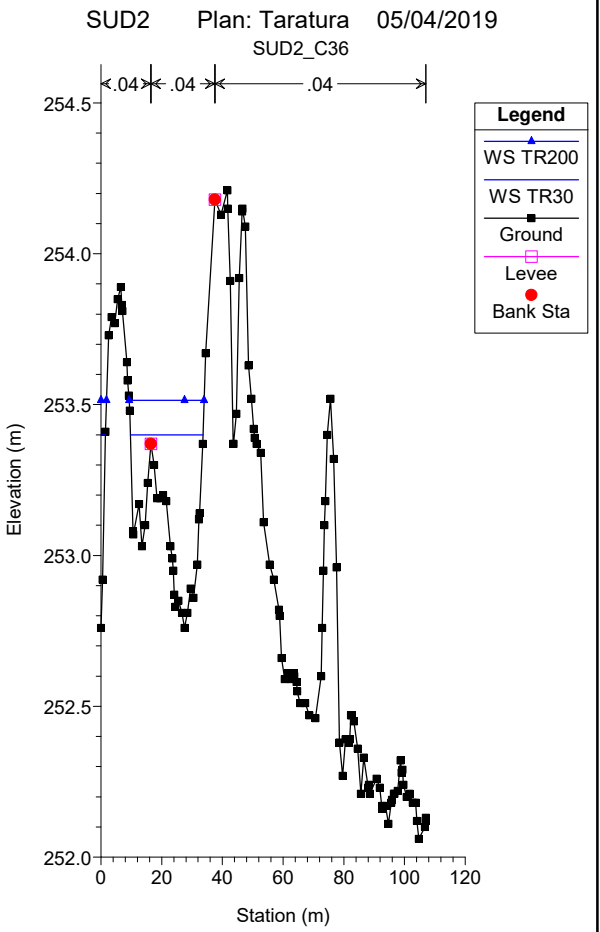
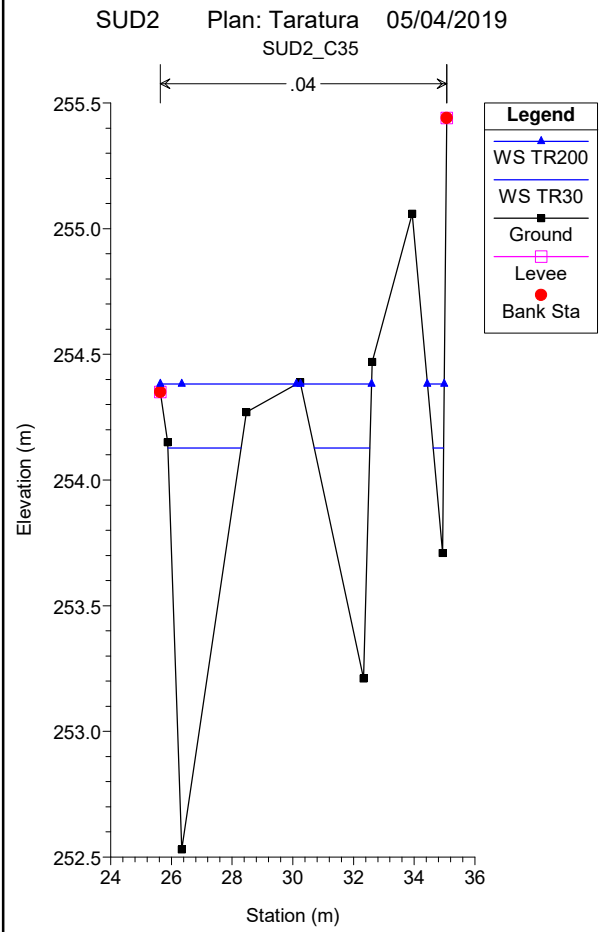
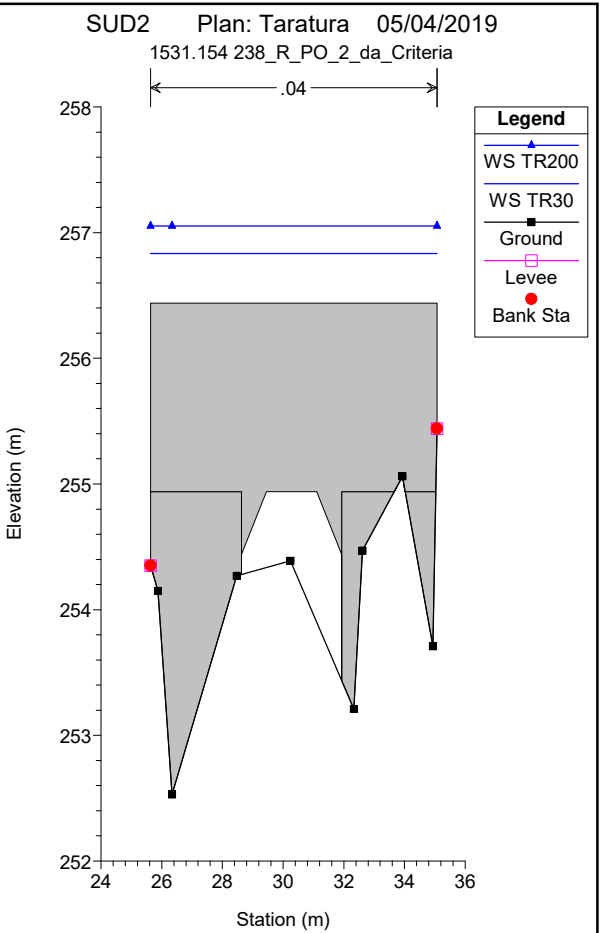
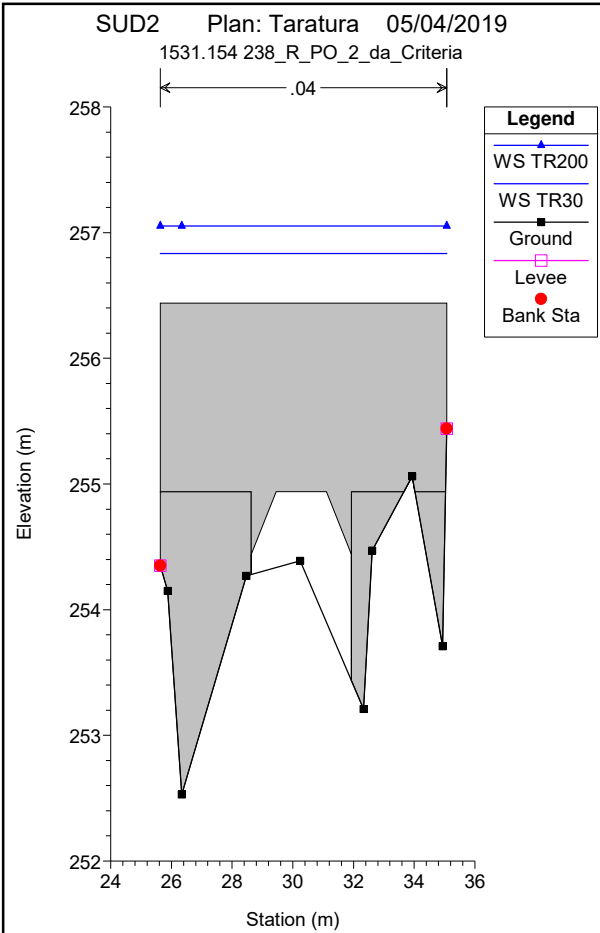

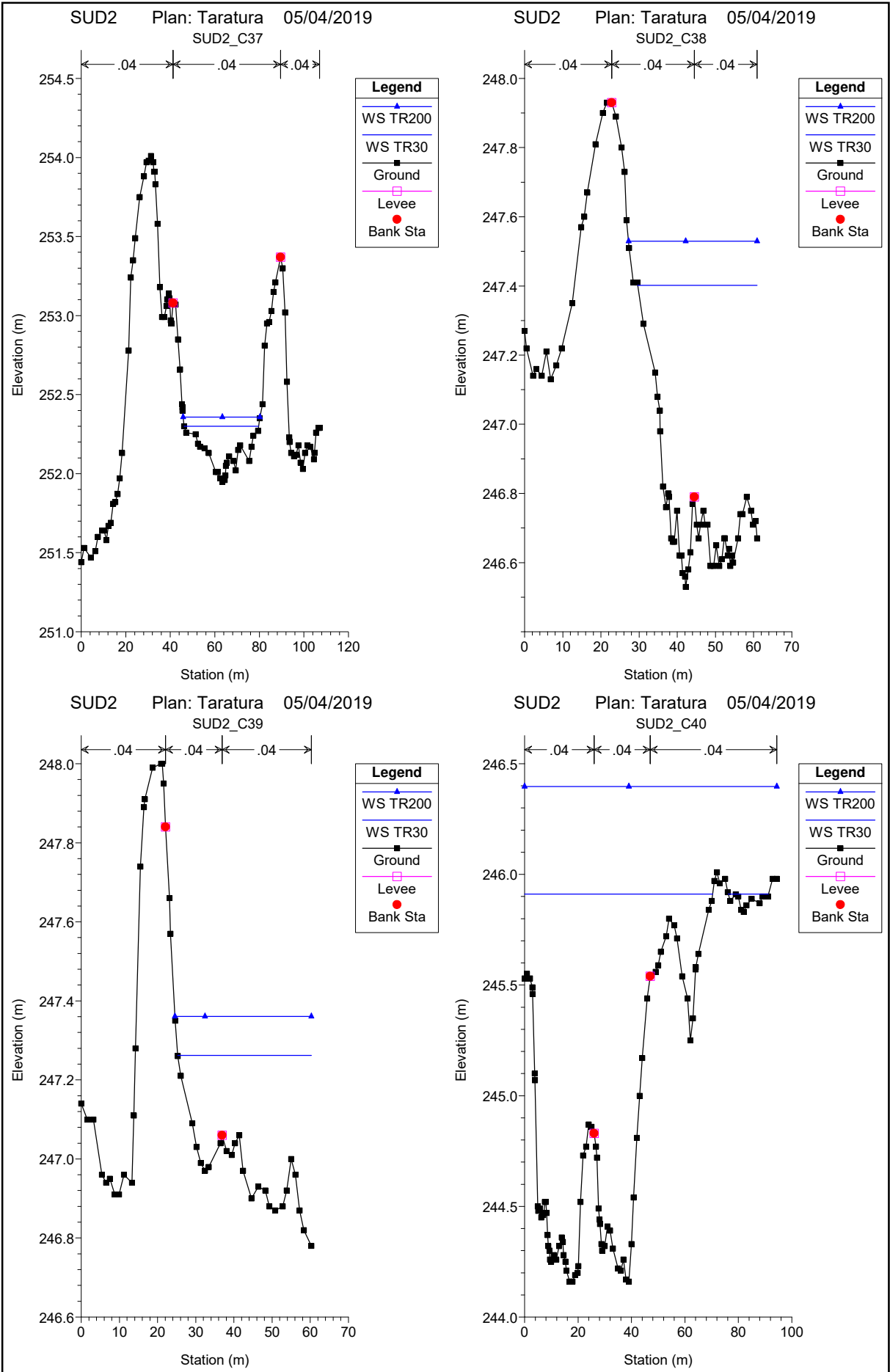

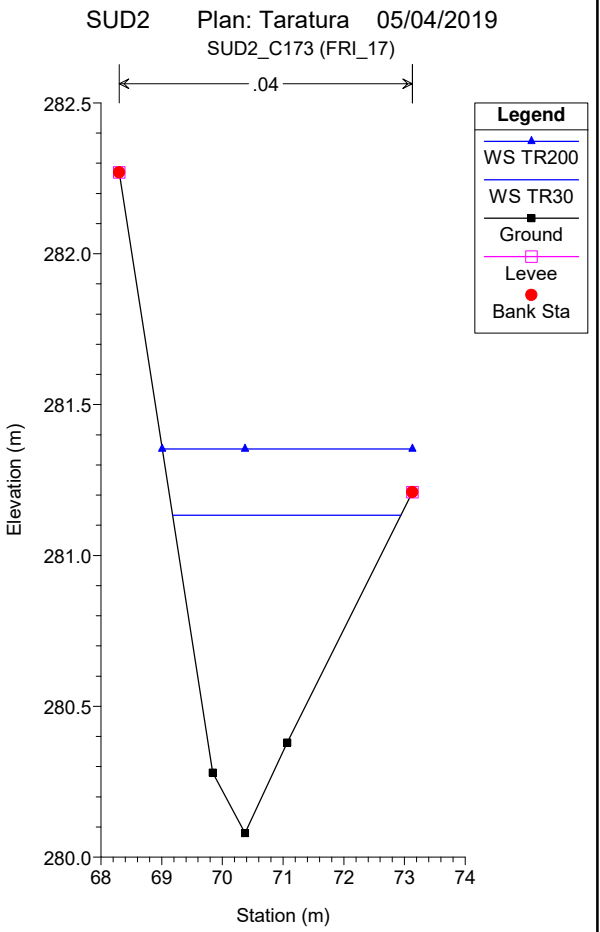
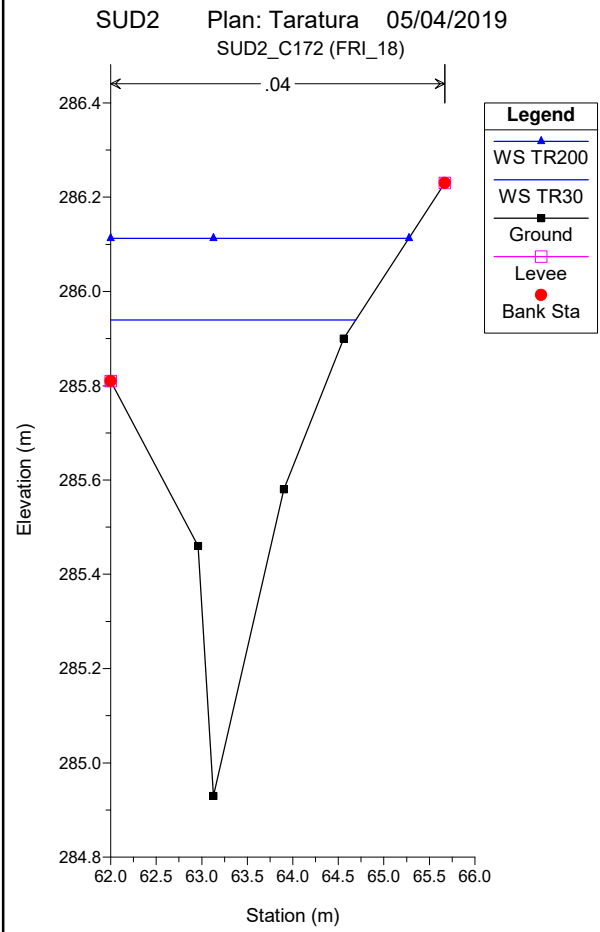
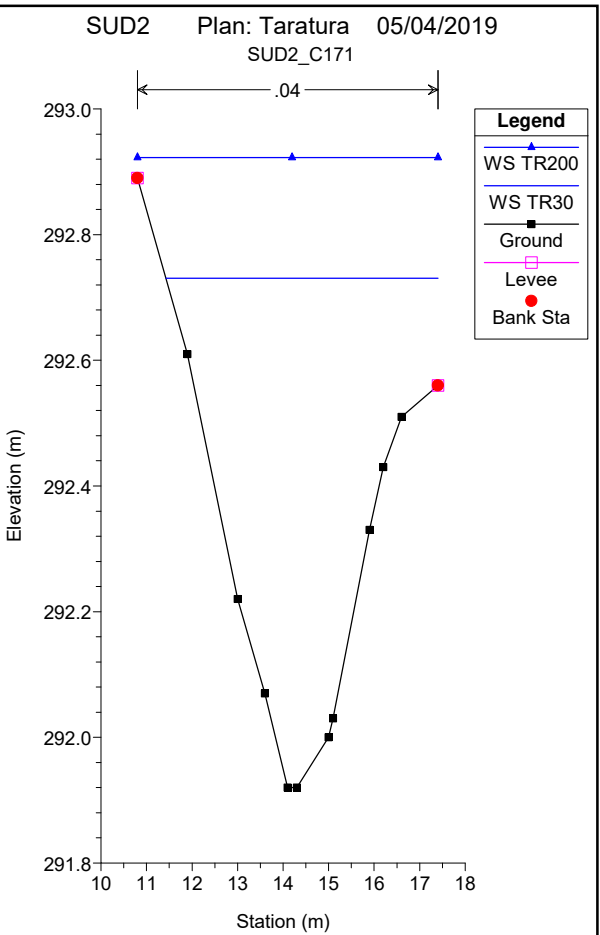
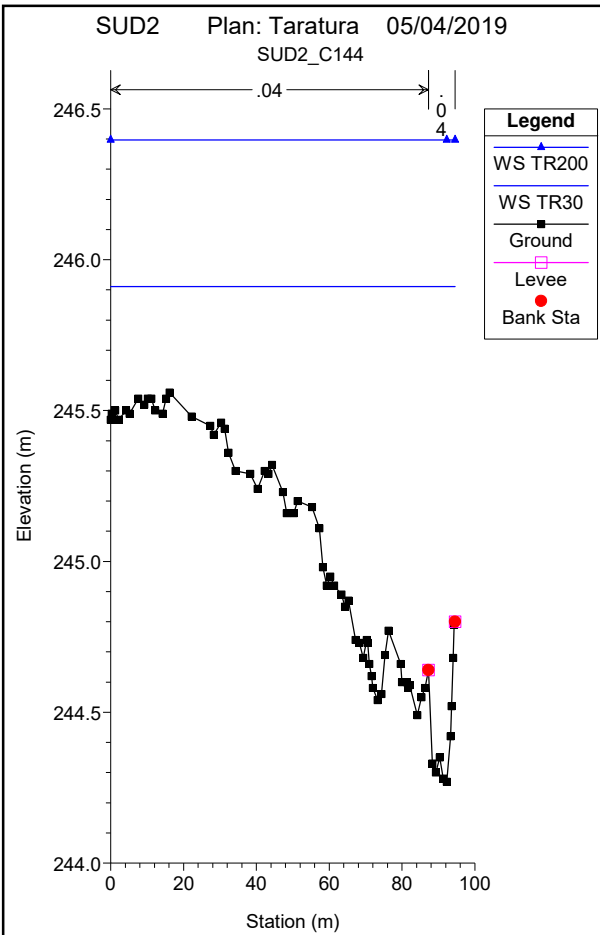

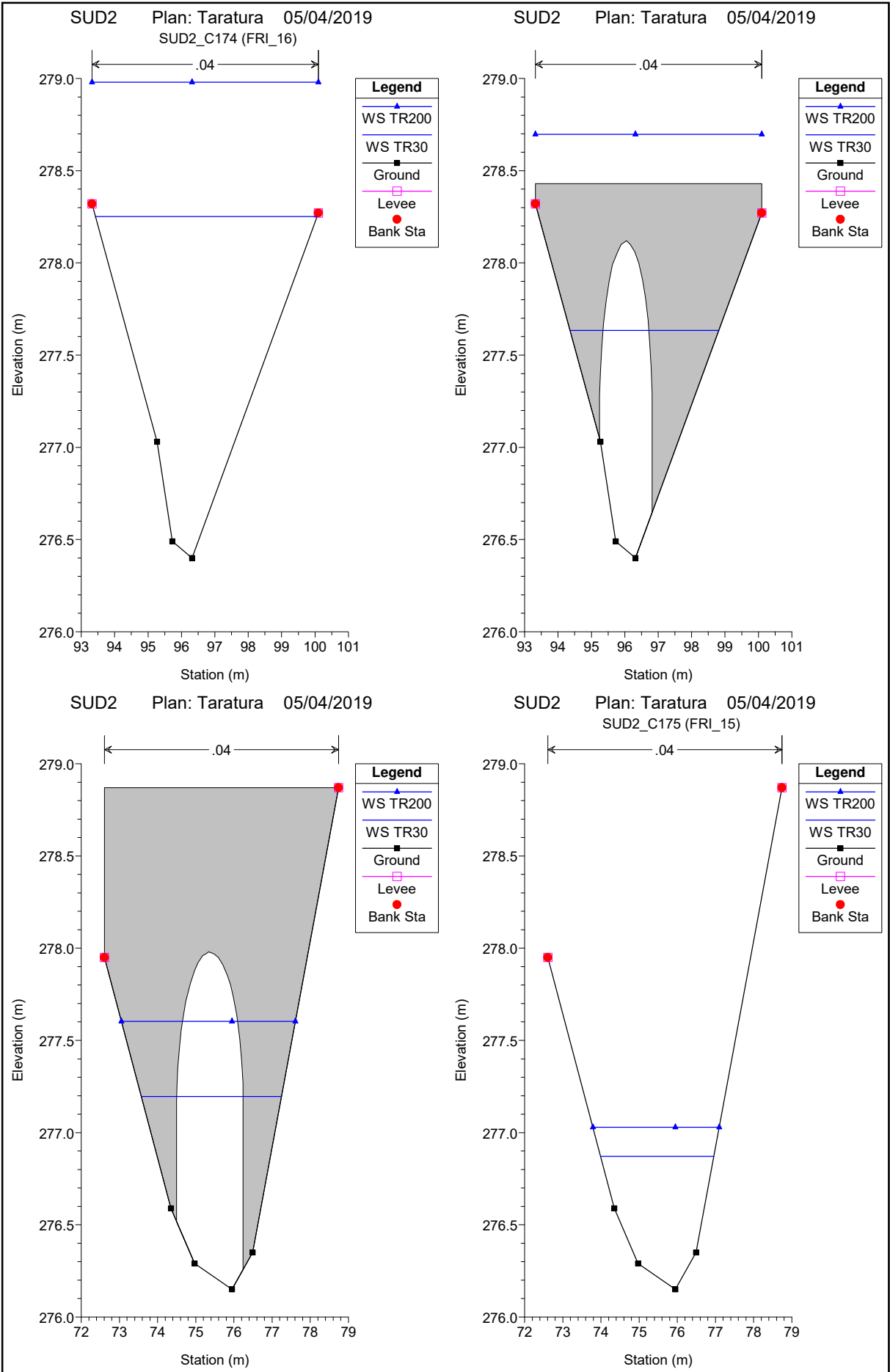

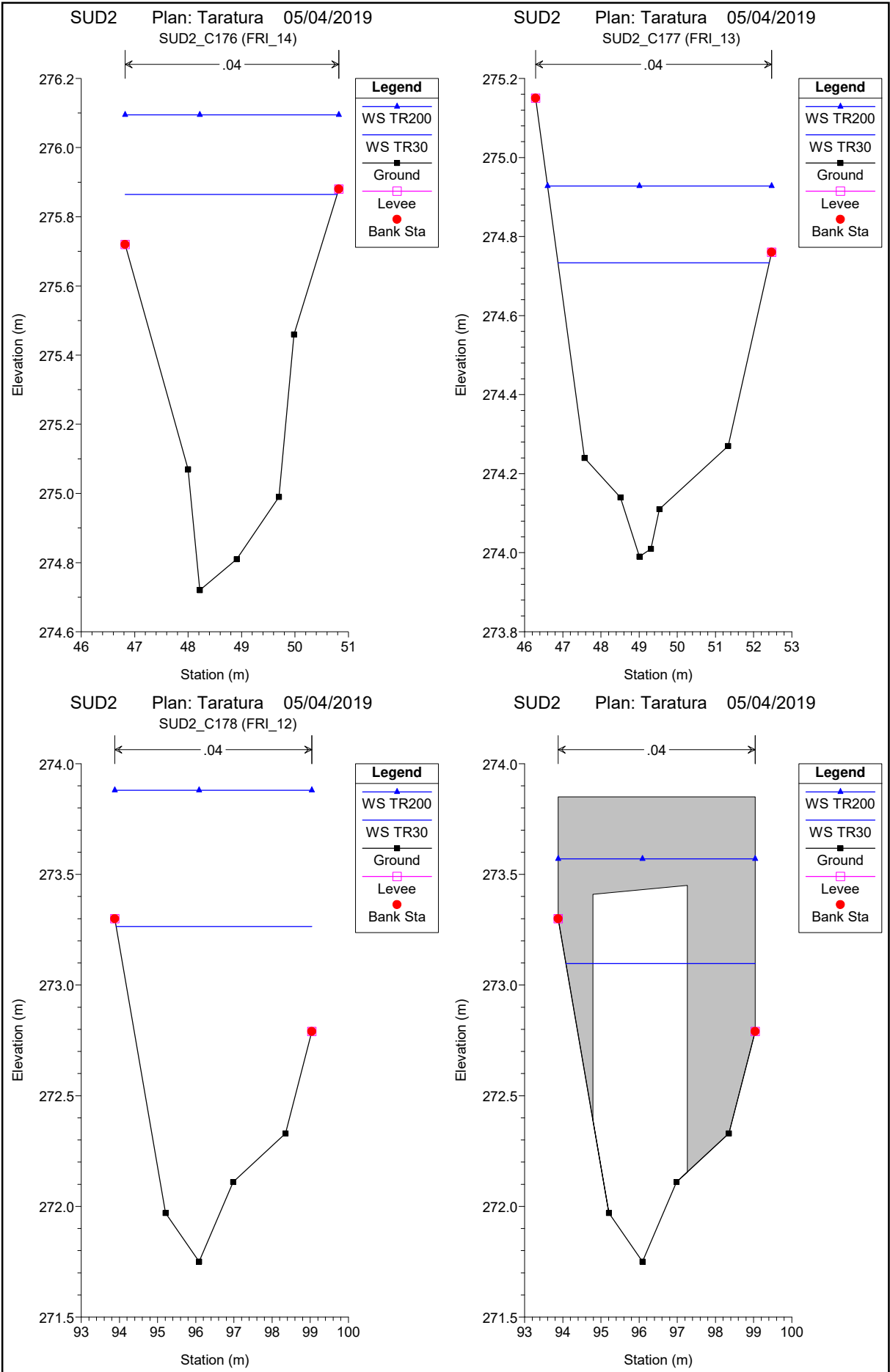

SUD2 Plan: Taratura 05/04/2019

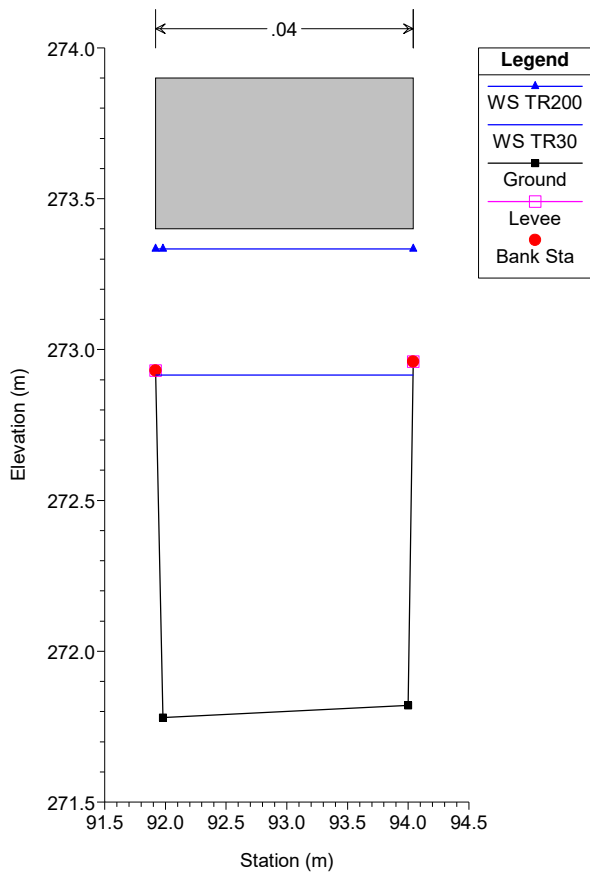

SUD2 Plan: Taratura 05/04/2019
SUD2_C179 (FRI_11)

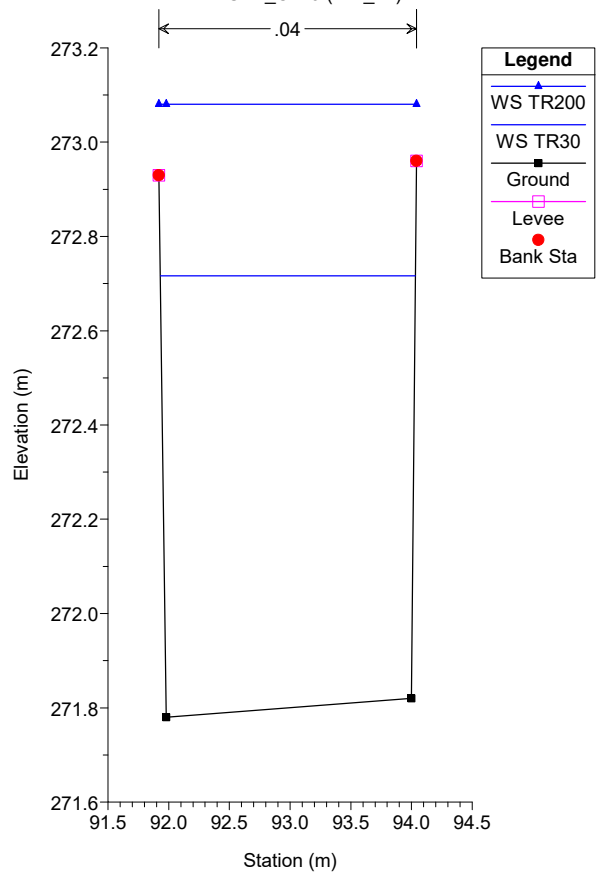

SUD2 Plan: Taratura 05/04/2019
SUD2_C180 (FRI_10)

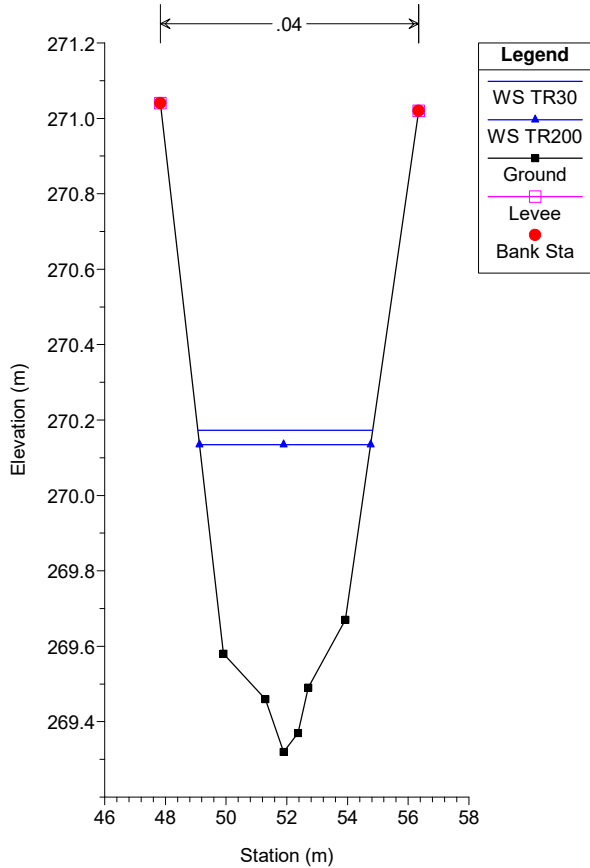

SUD2 Plan: Taratura 05/04/2019
SUD2_C181 (FRI_09)

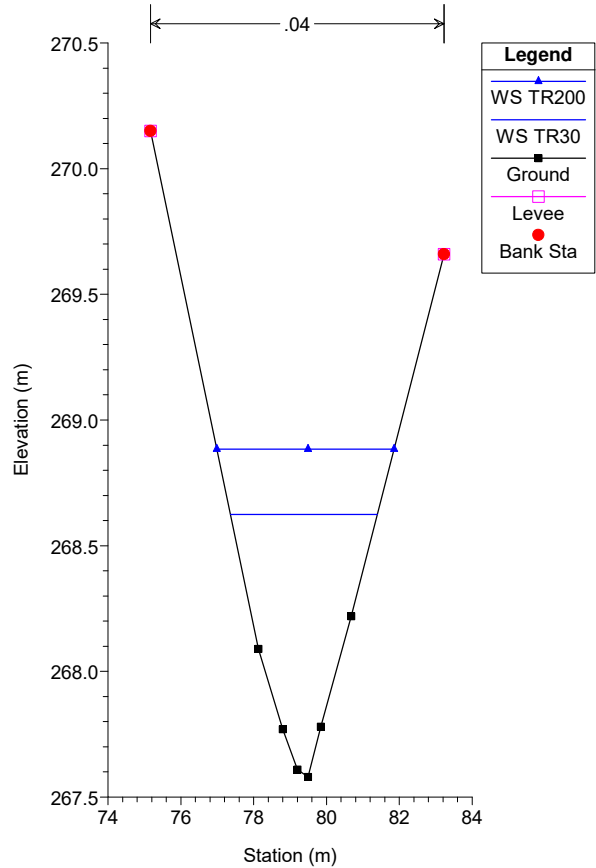

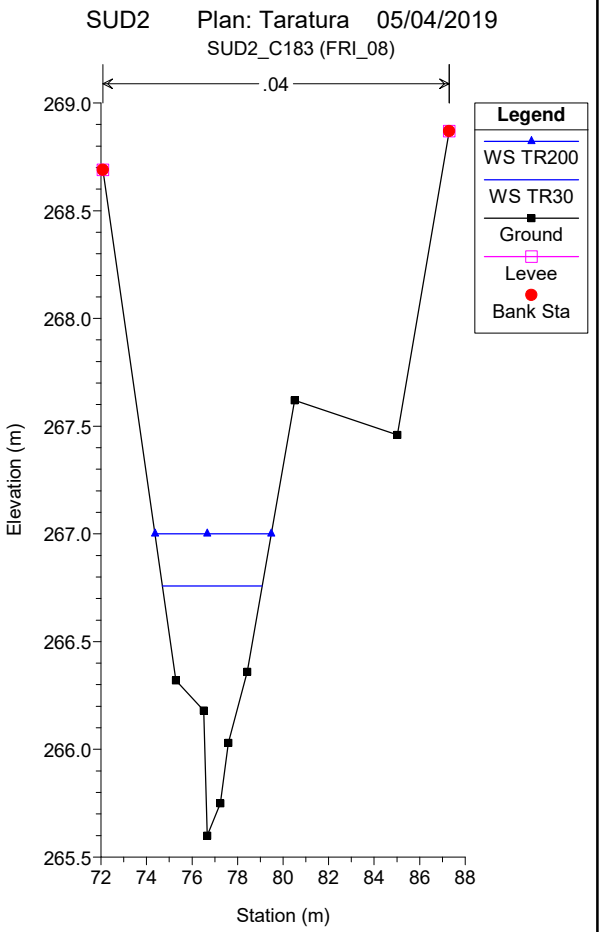
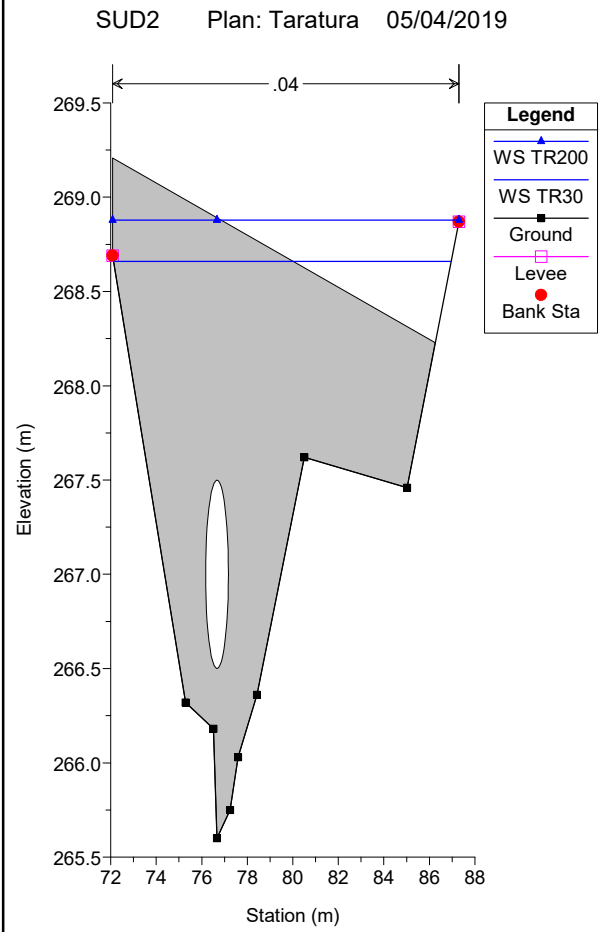
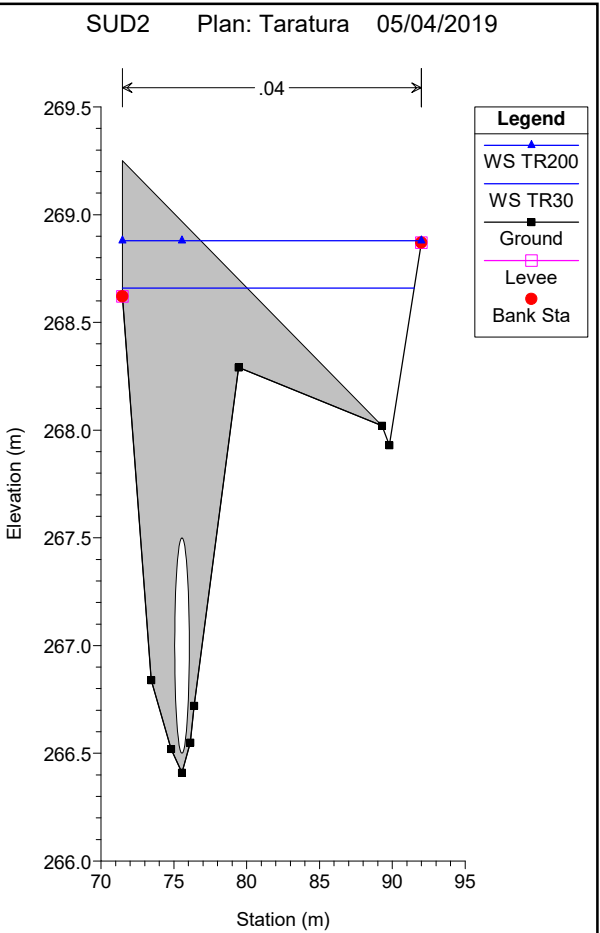
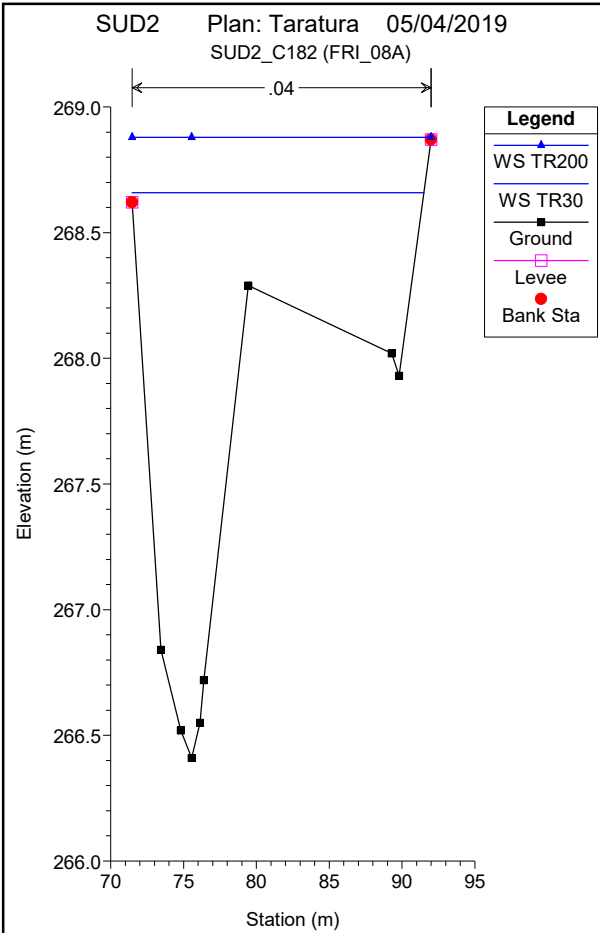

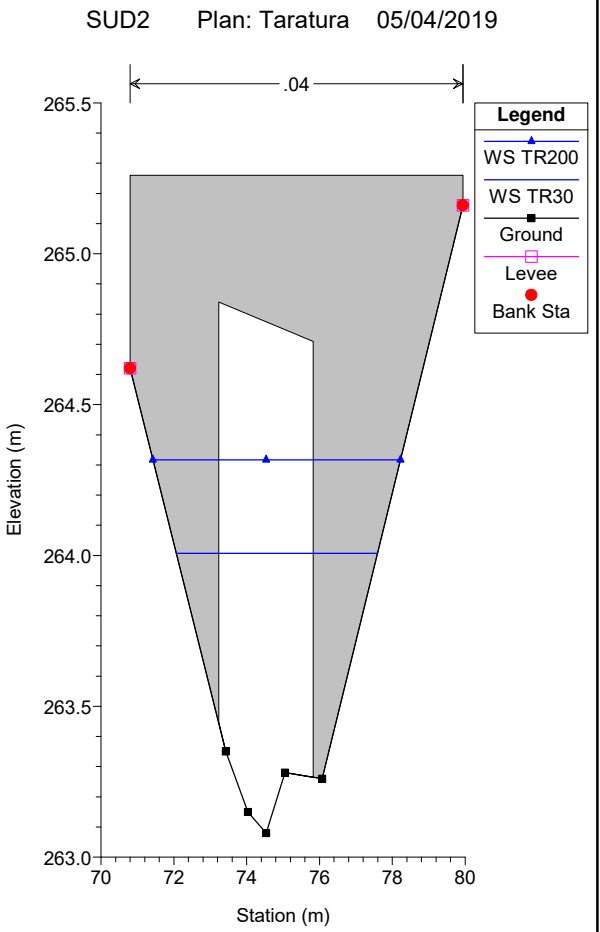
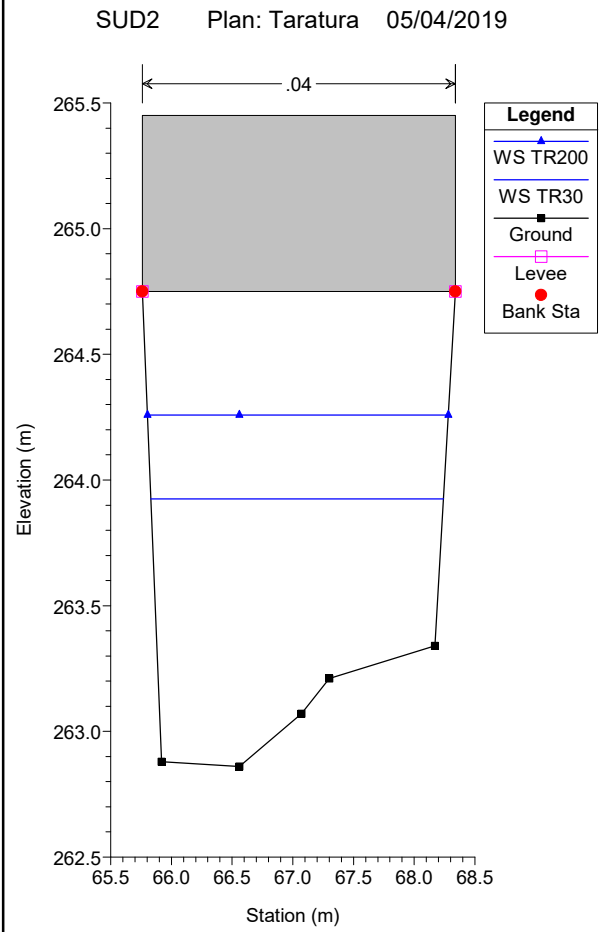
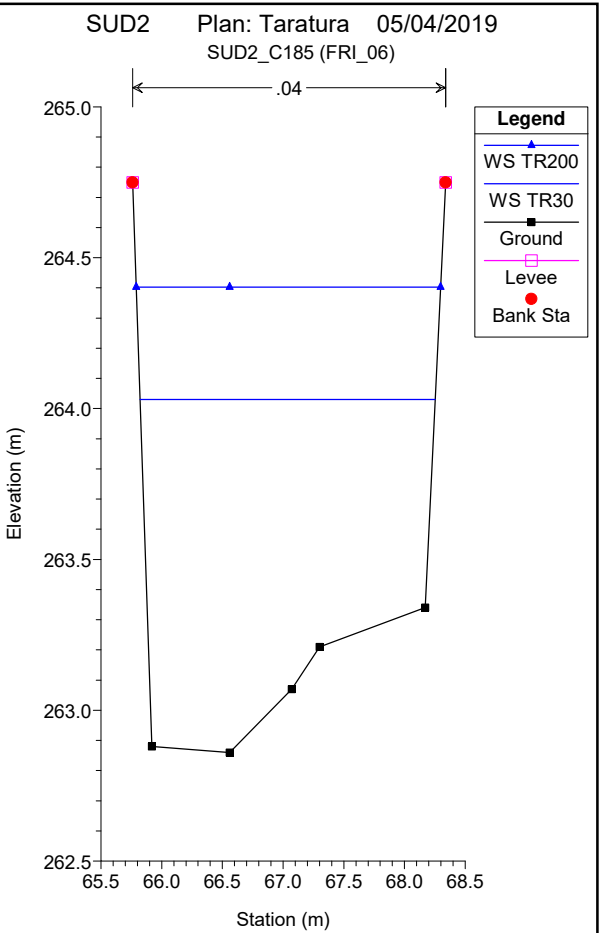
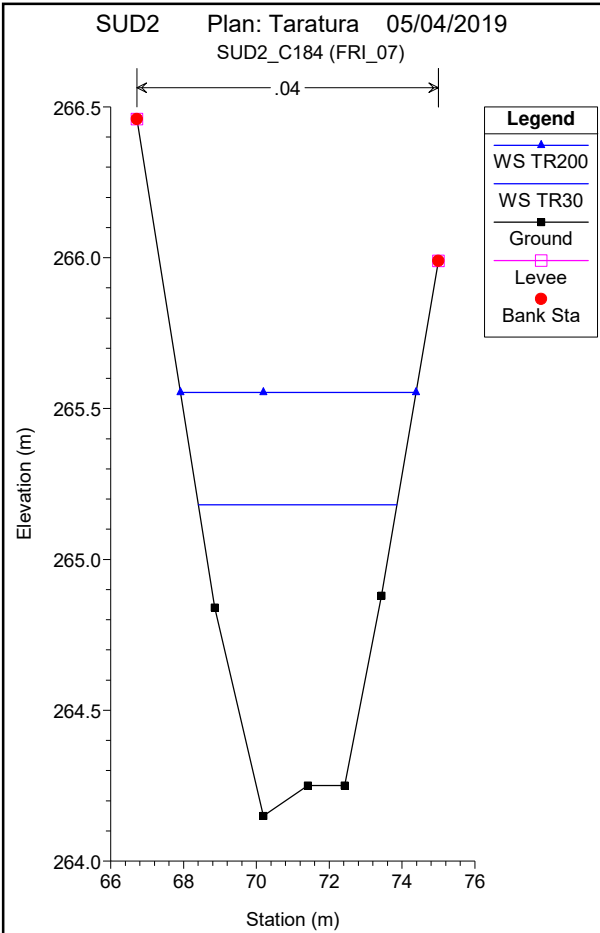

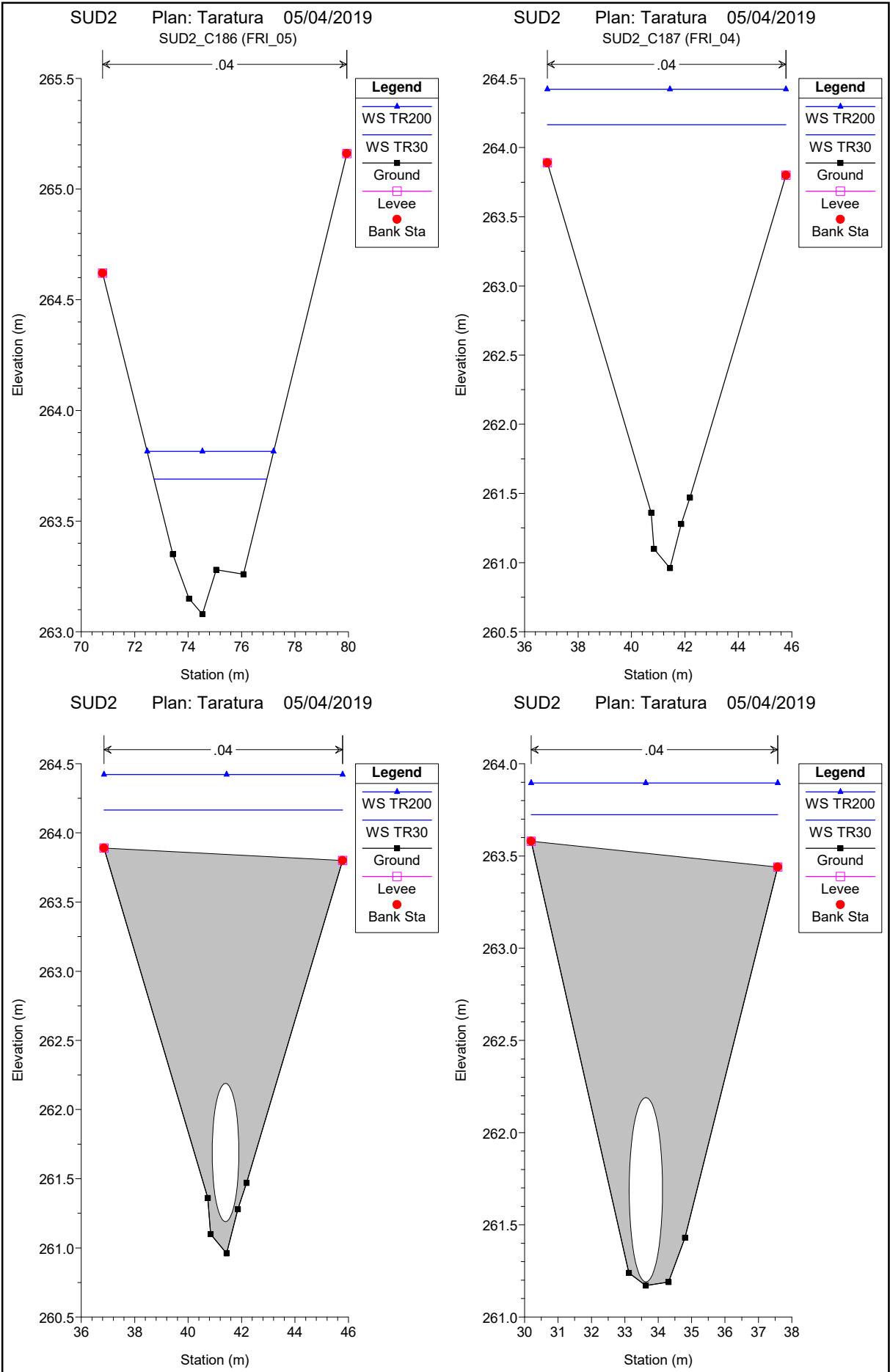

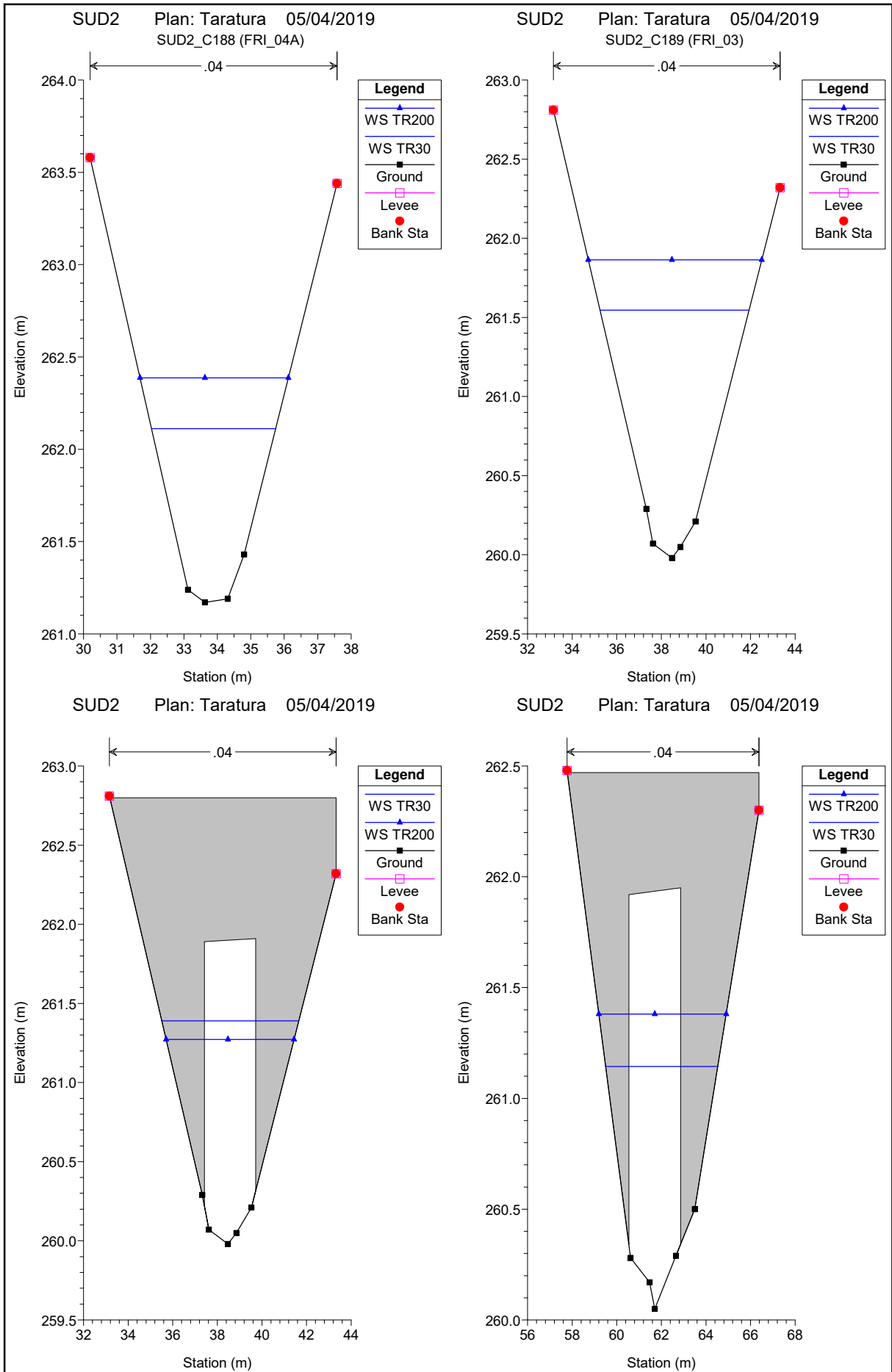

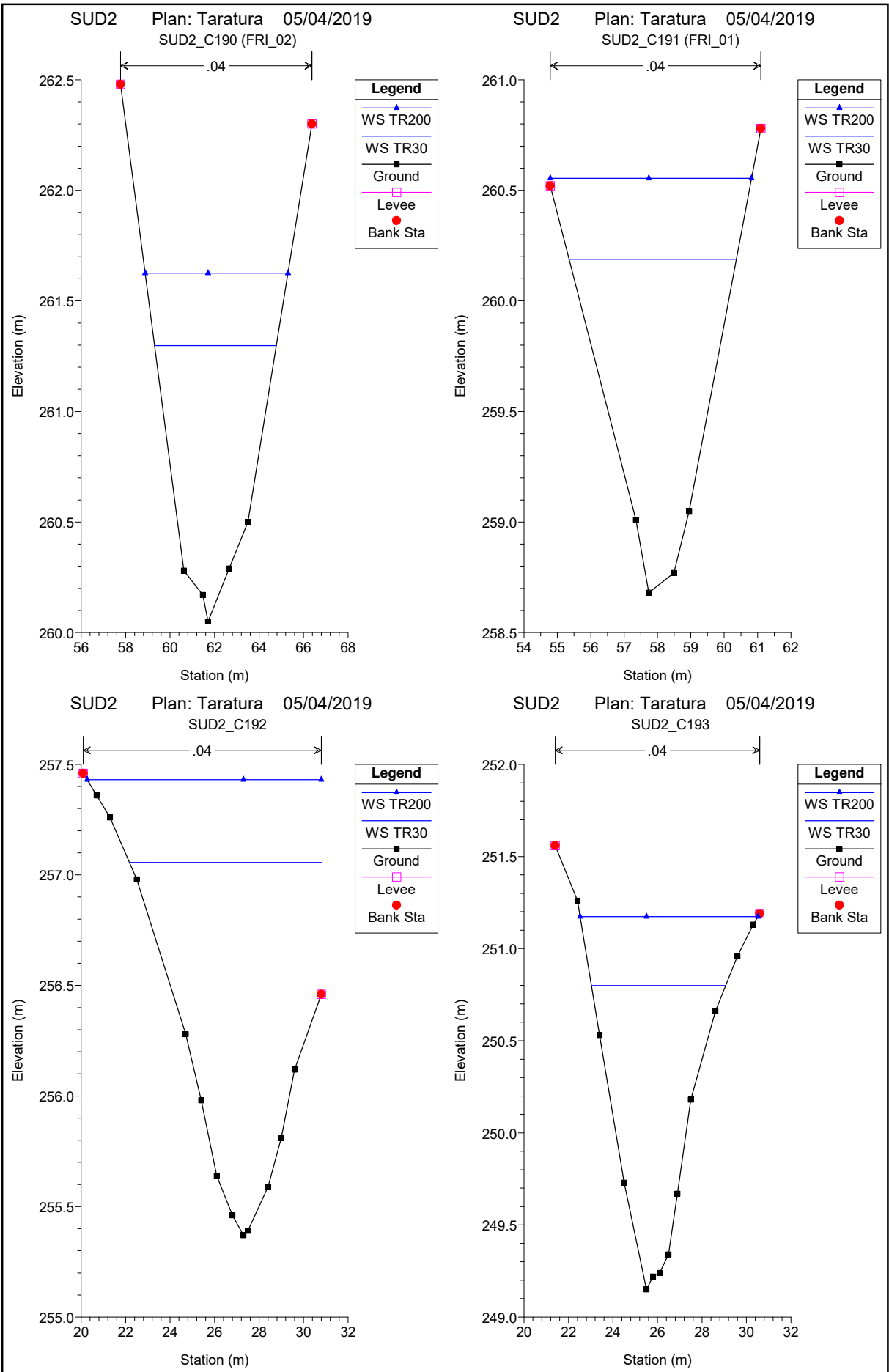

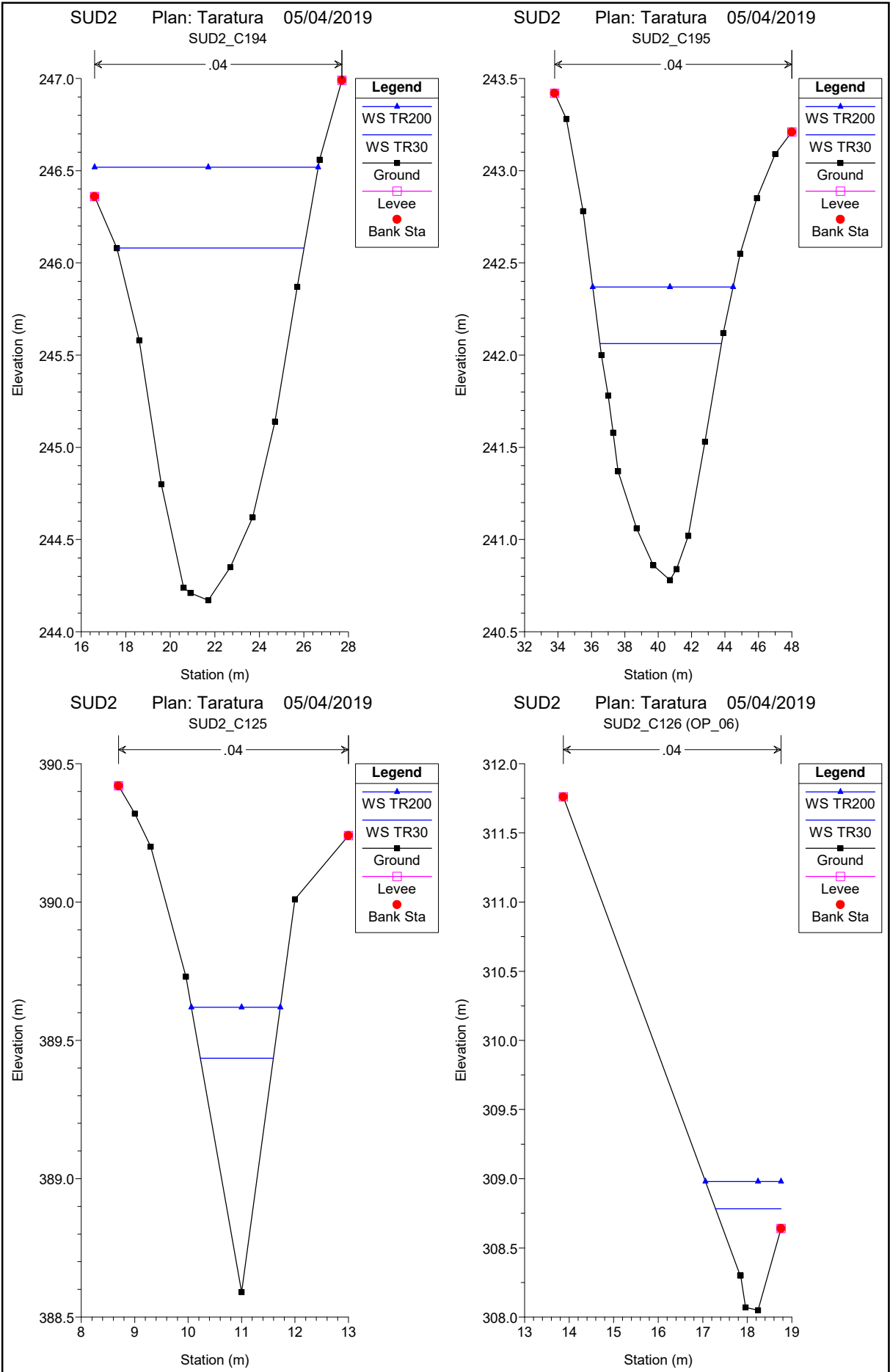

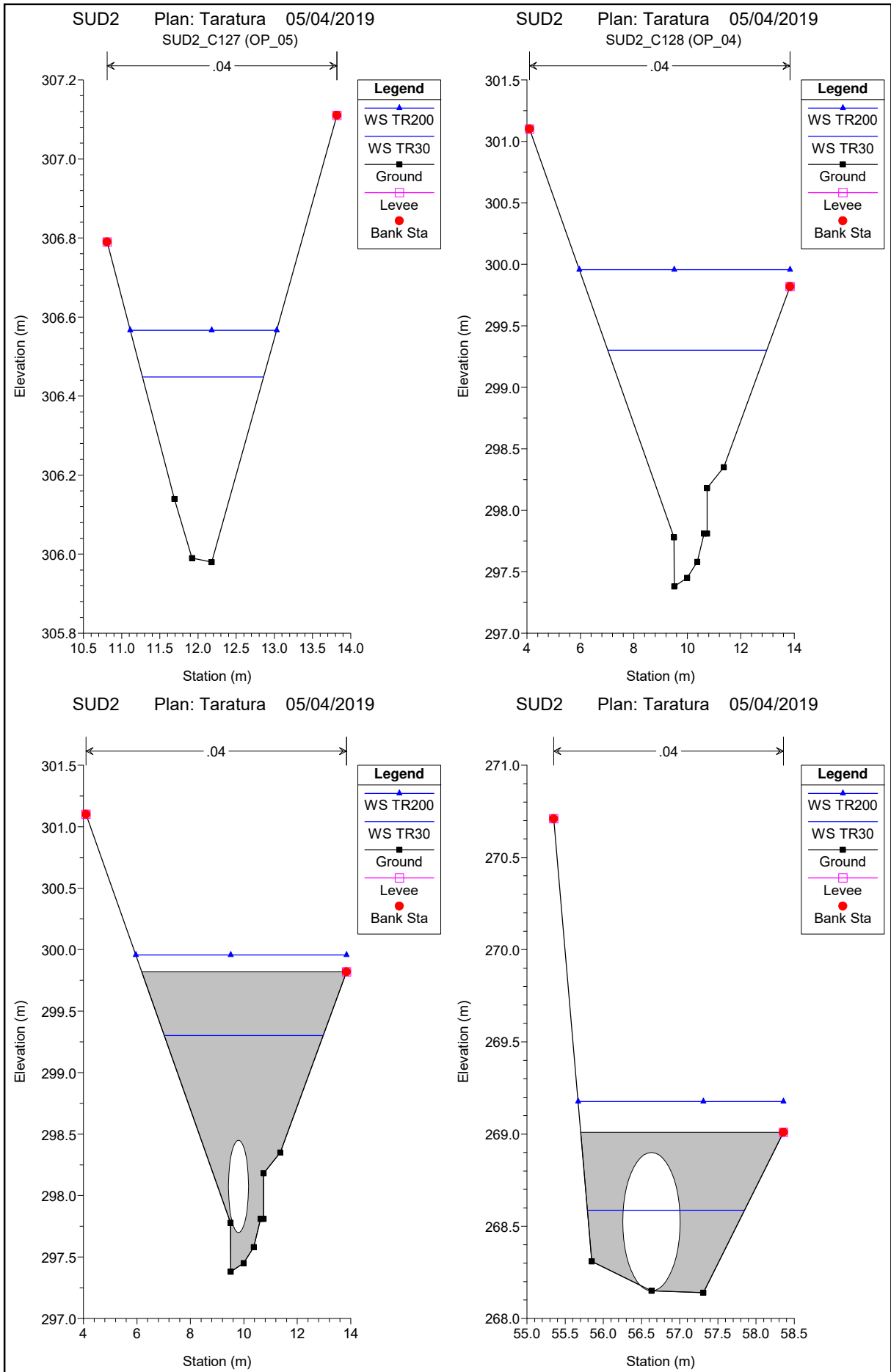

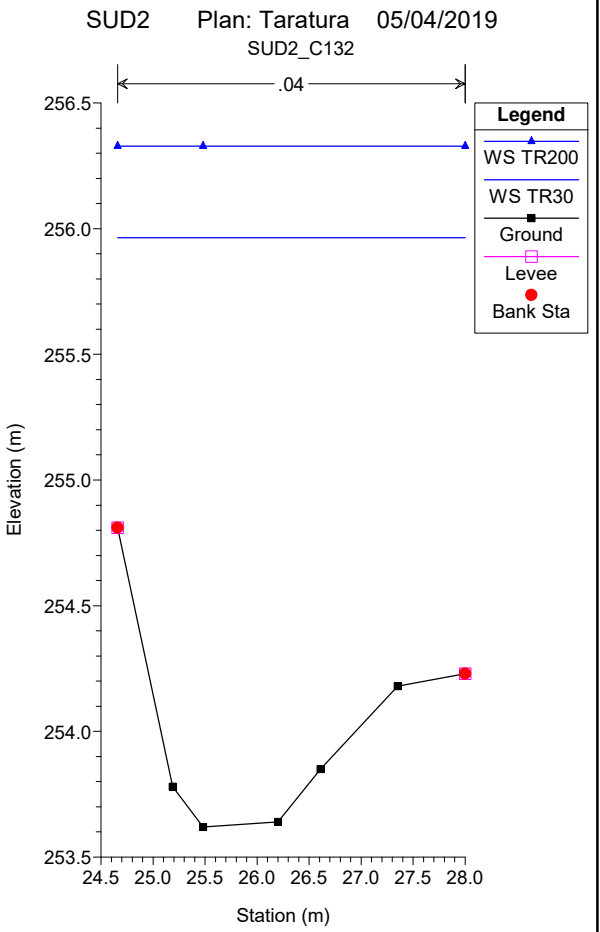
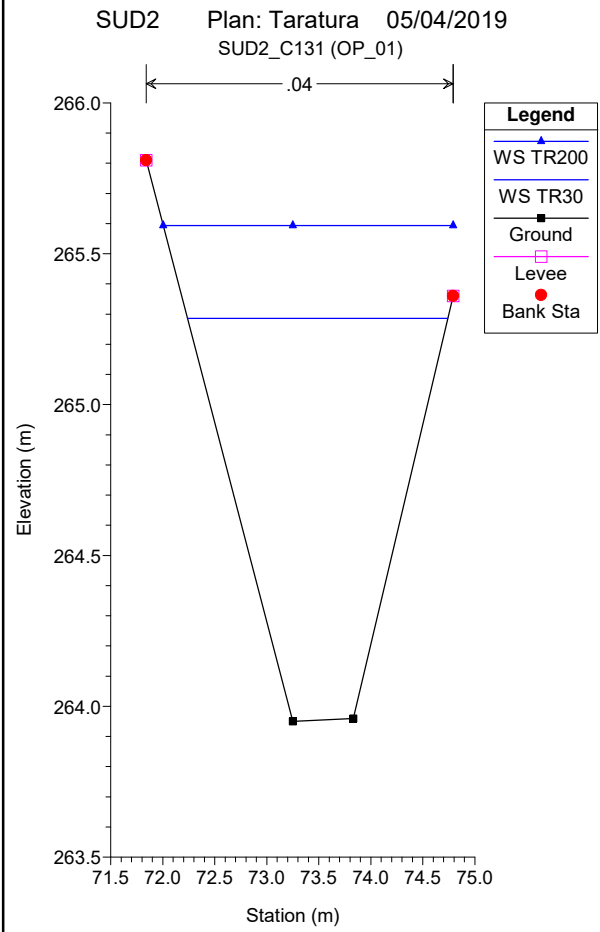
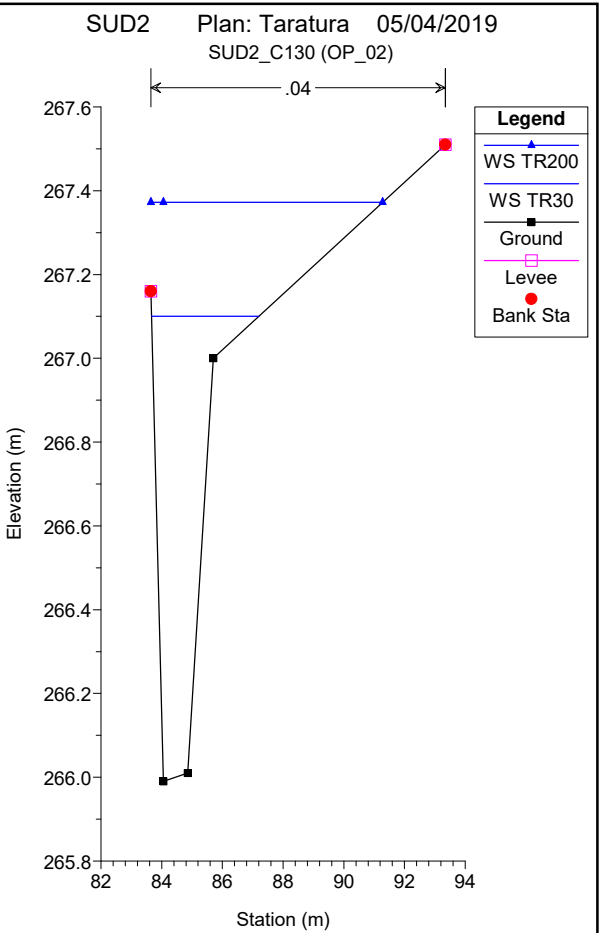
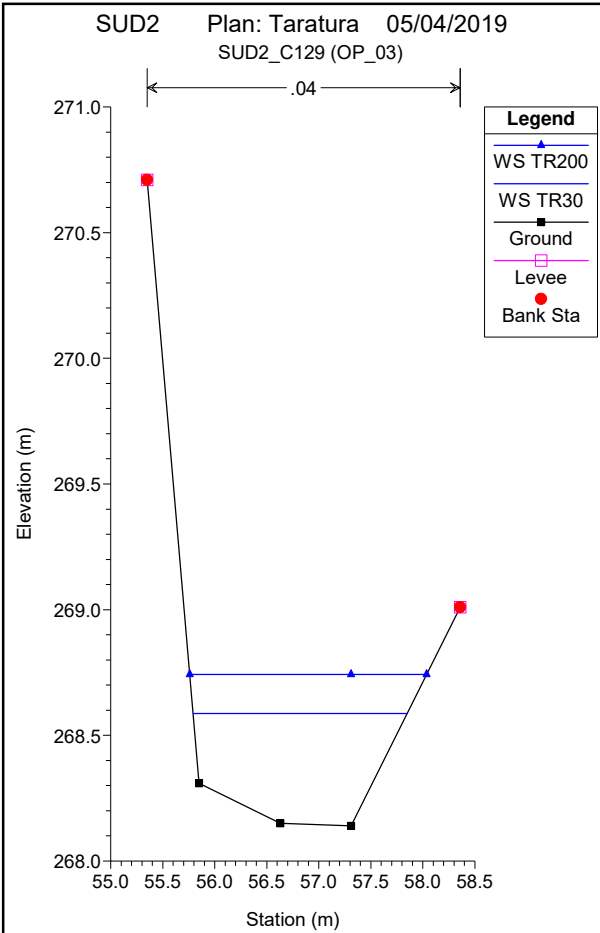

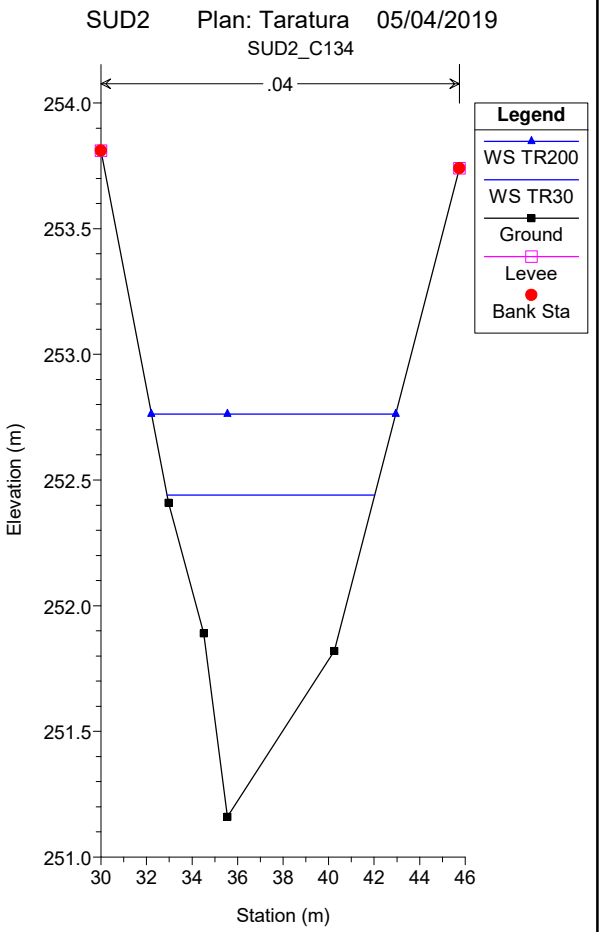
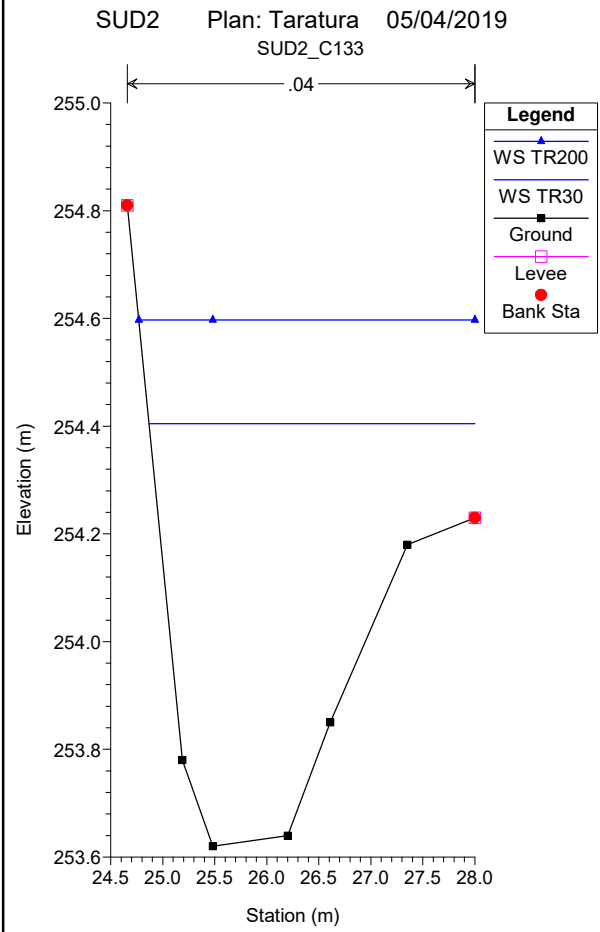
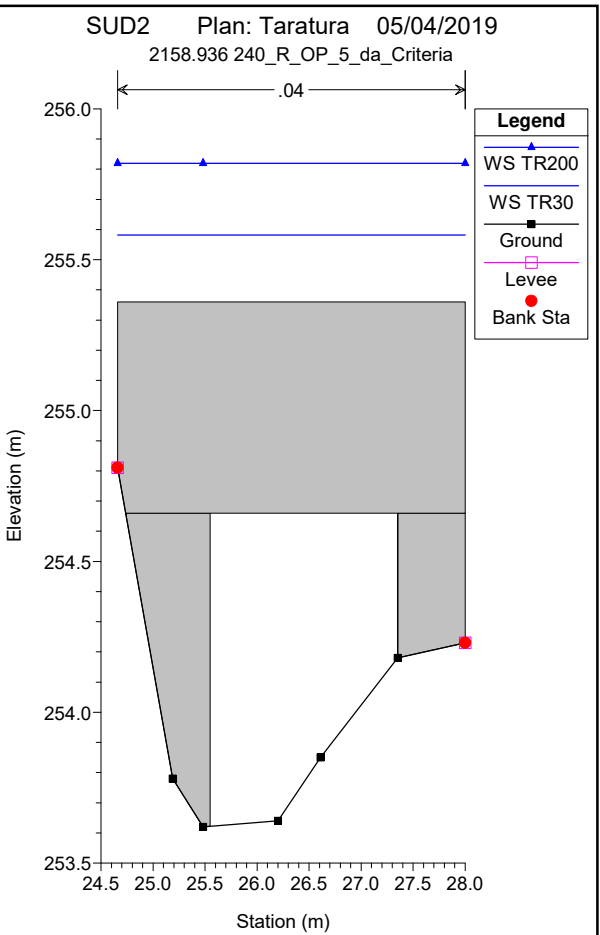
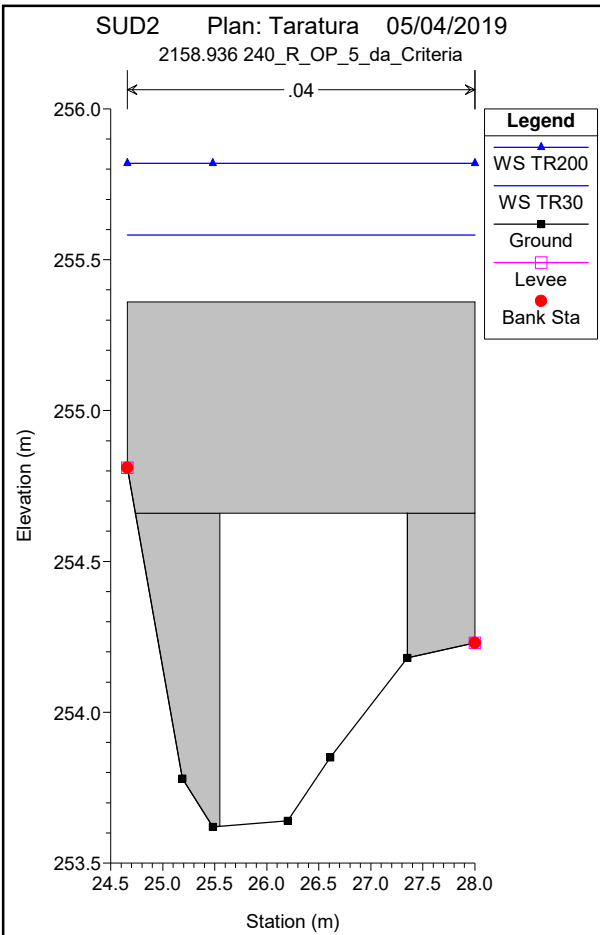

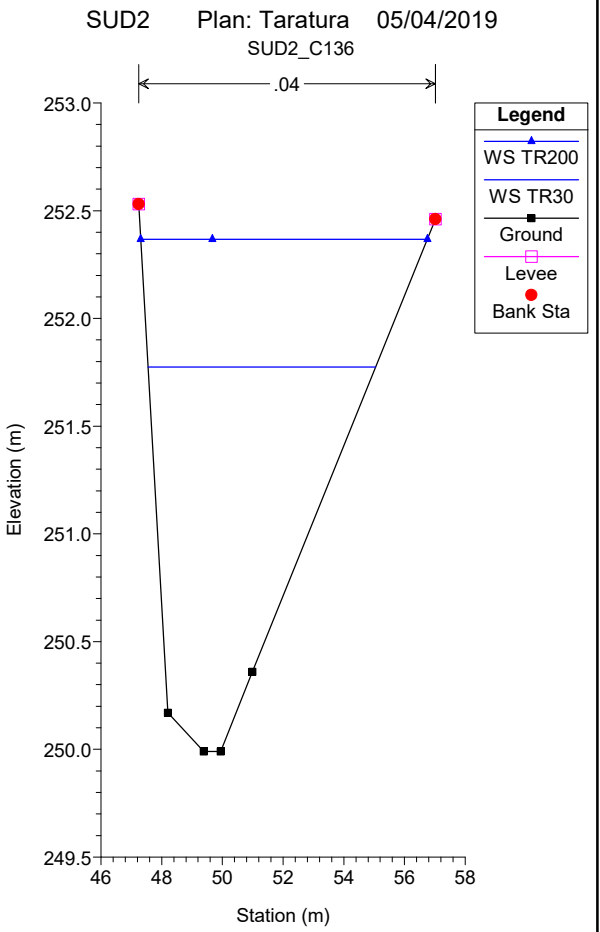
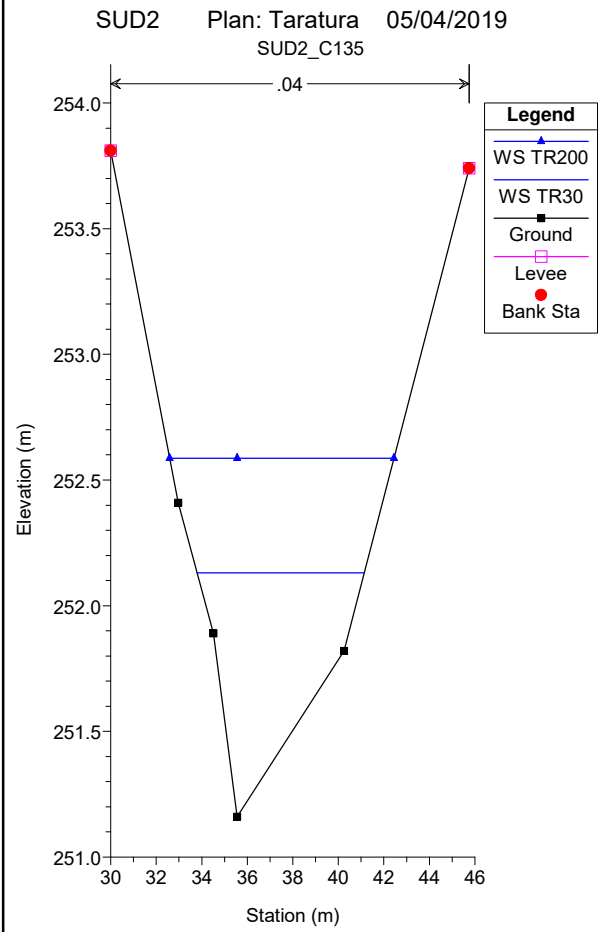
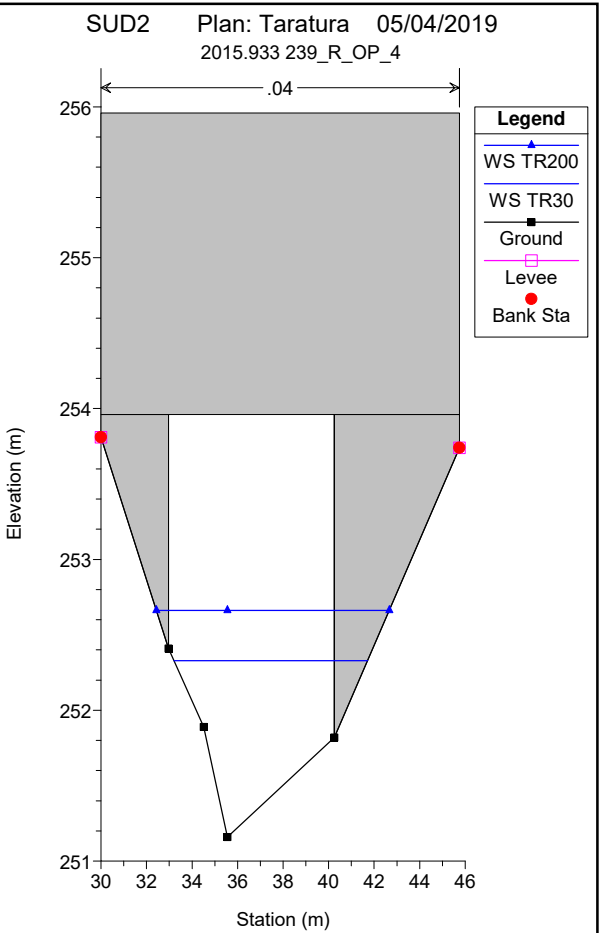
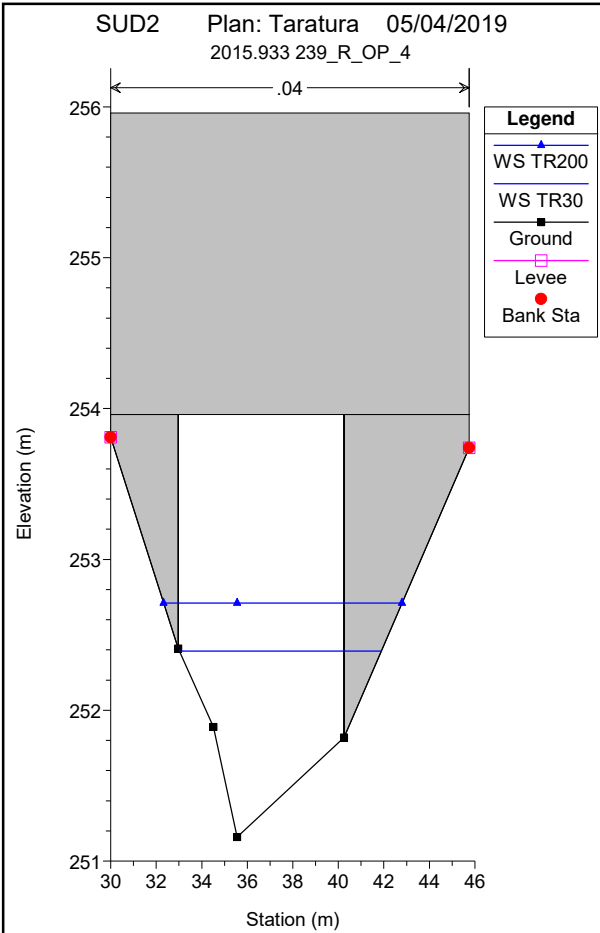

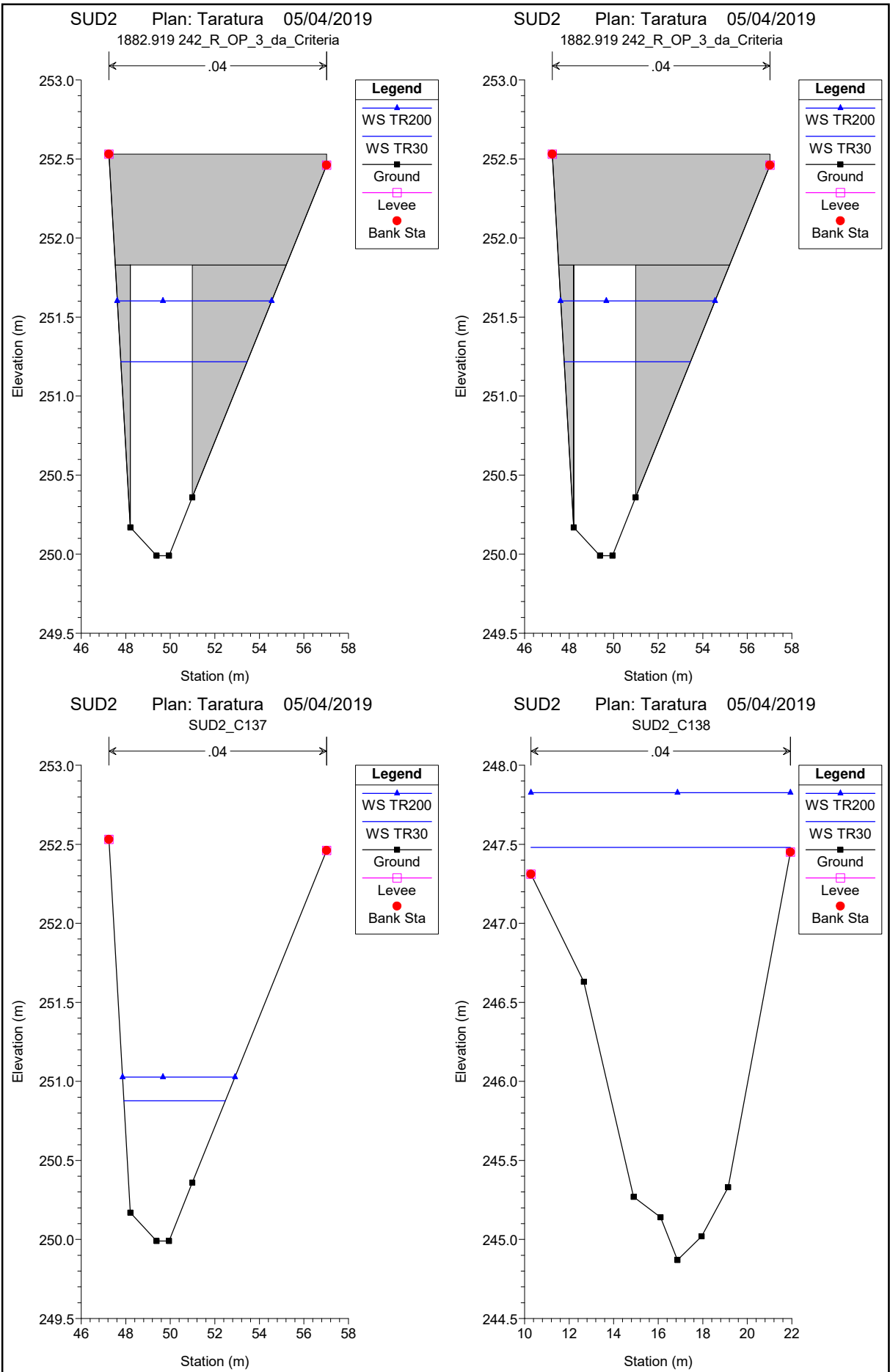

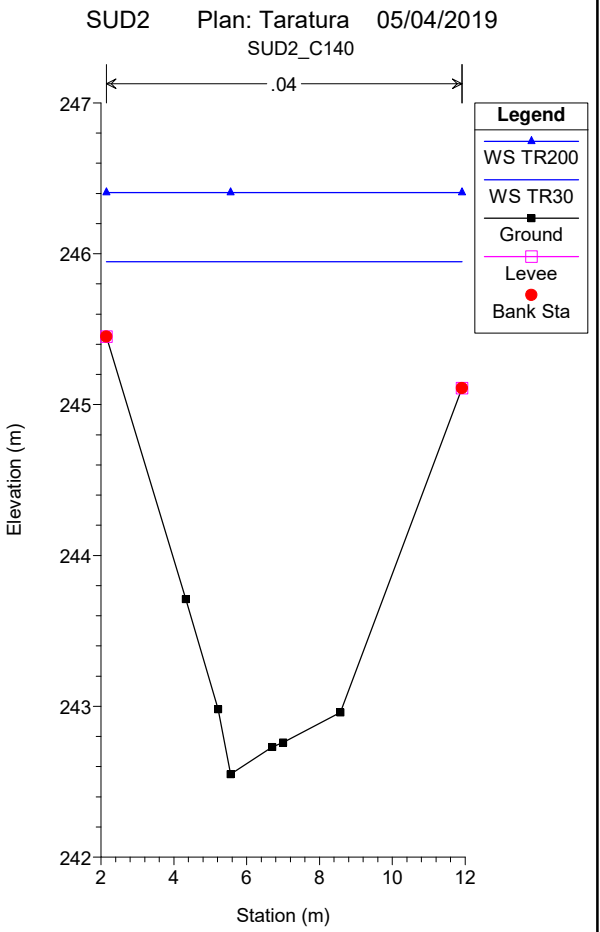
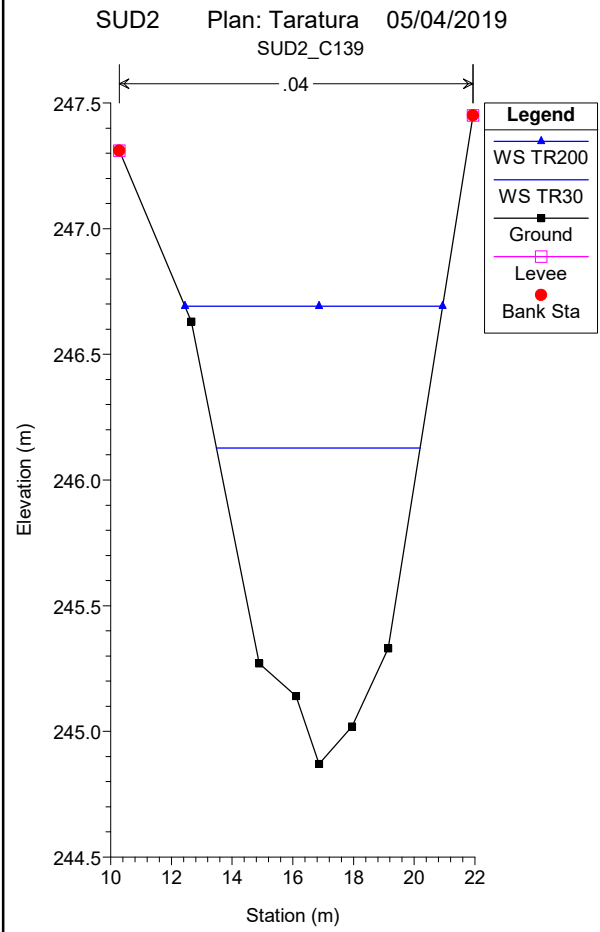
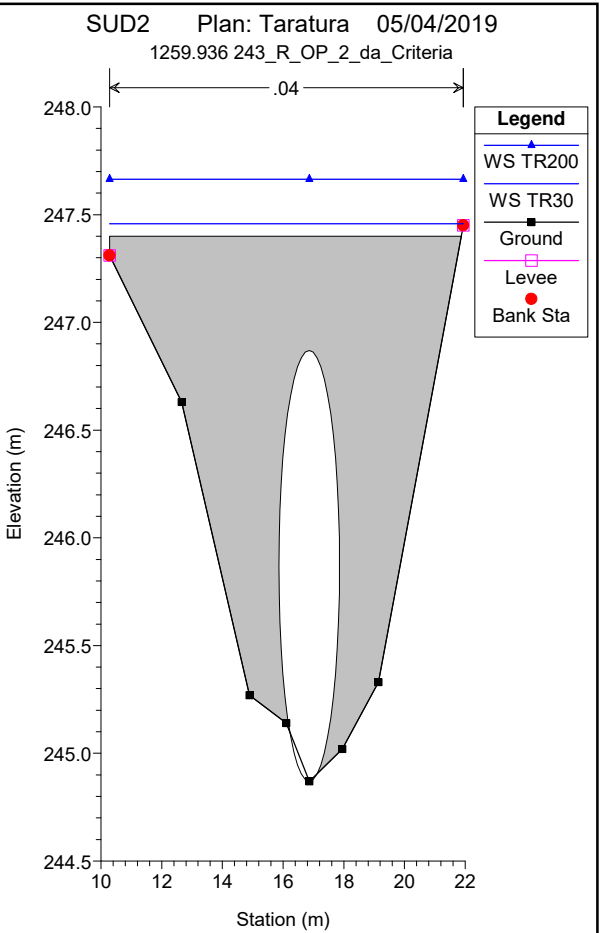
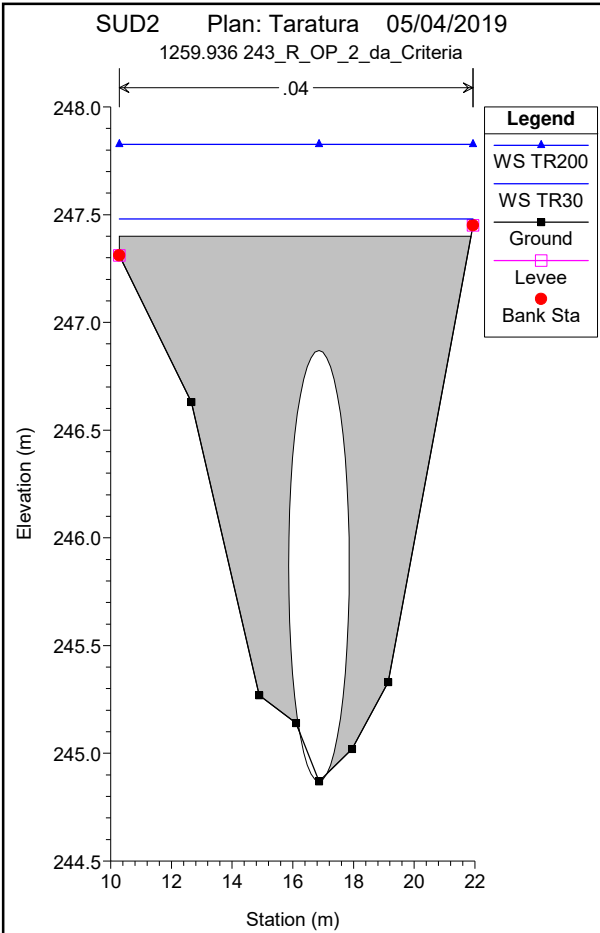

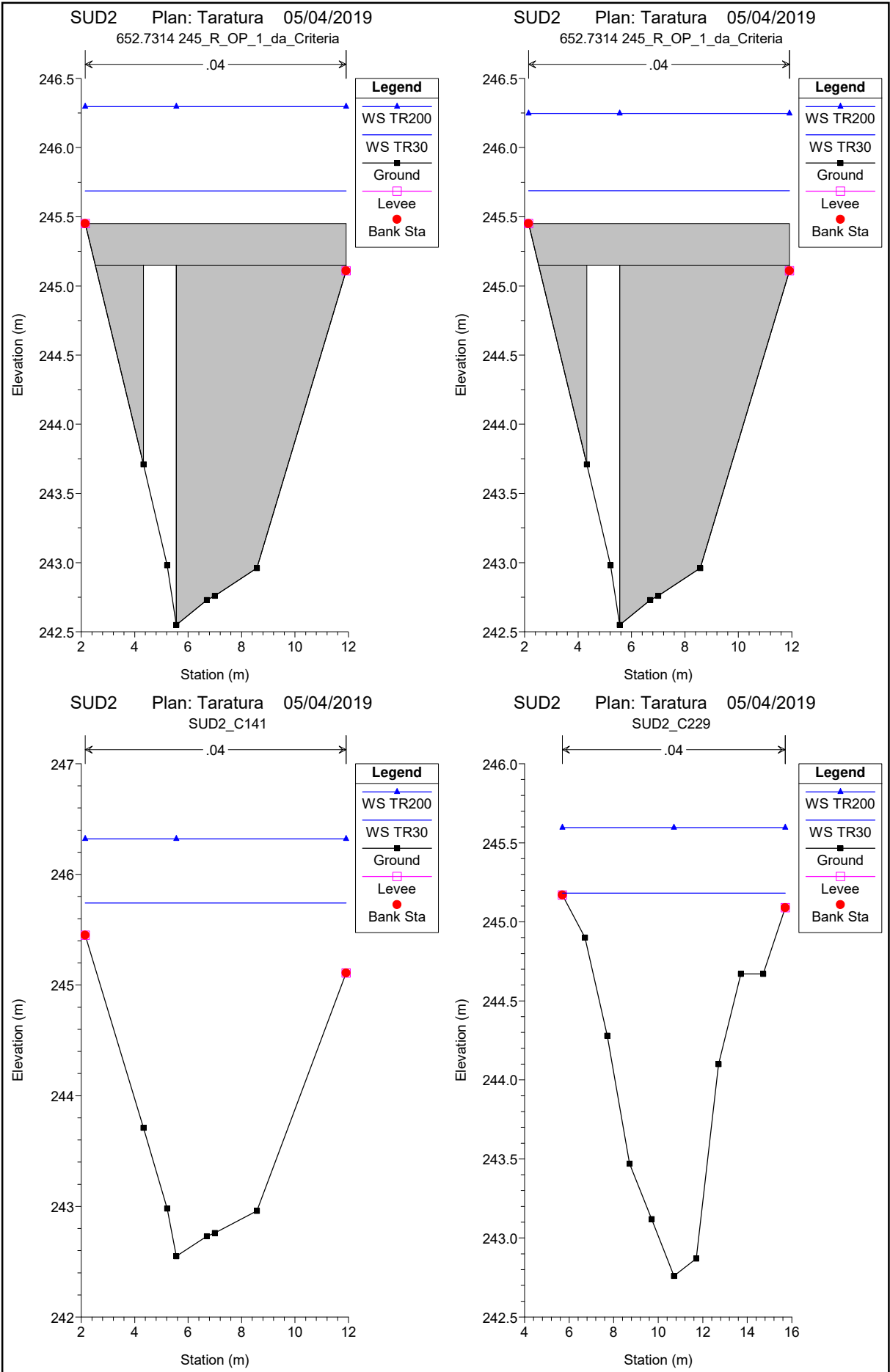

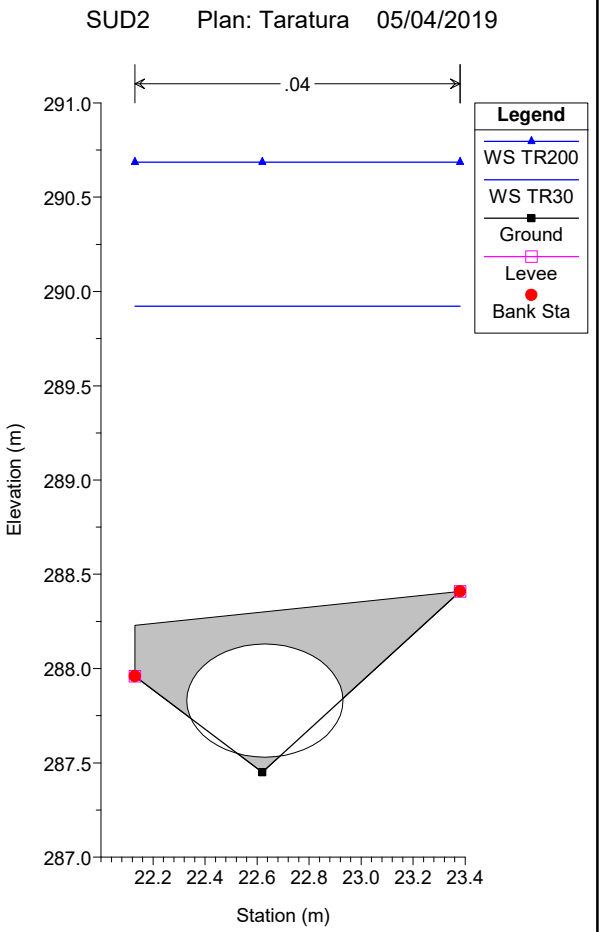
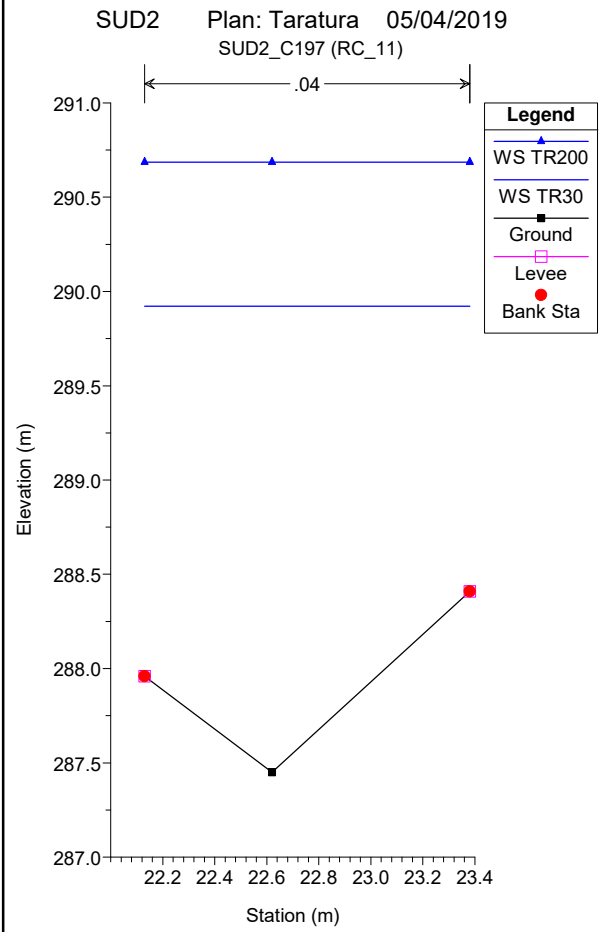
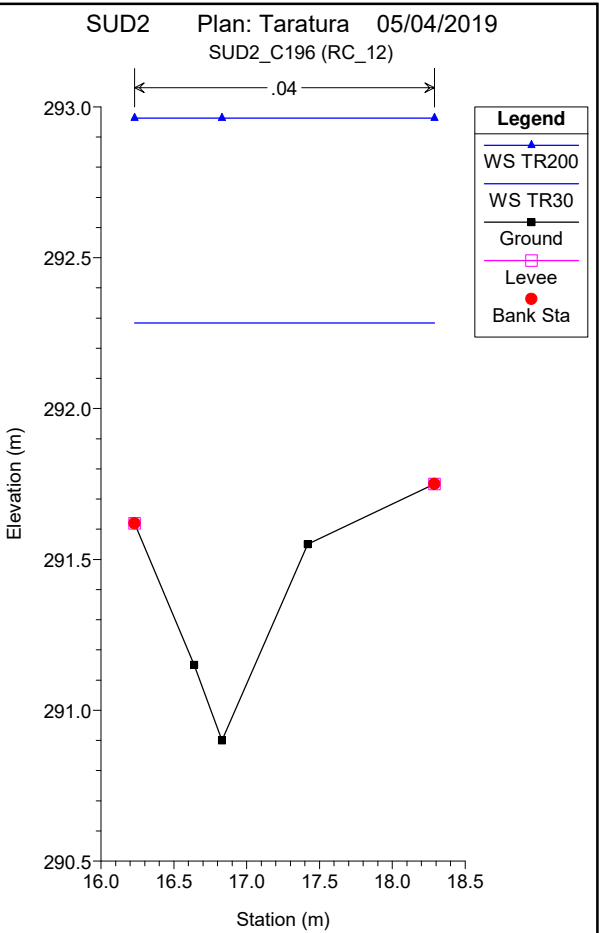
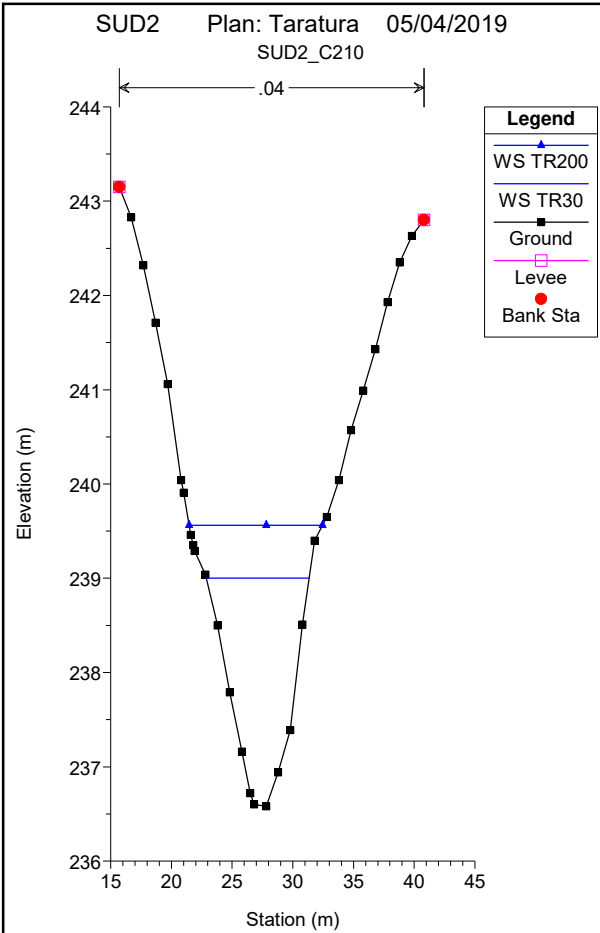

SUD2 Plan: Taratura 05/04/2019

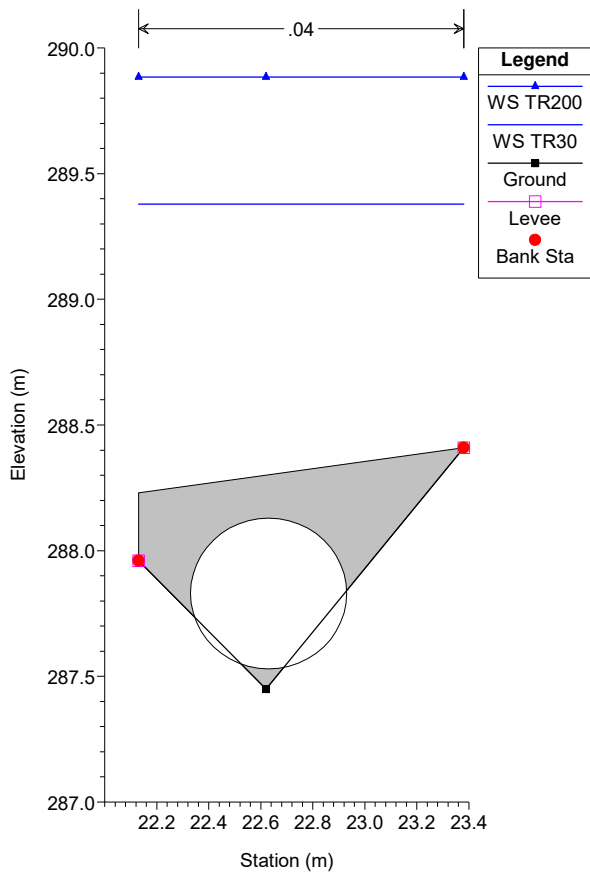

SUD2 Plan: Taratura 05/04/2019
SUD2_C197

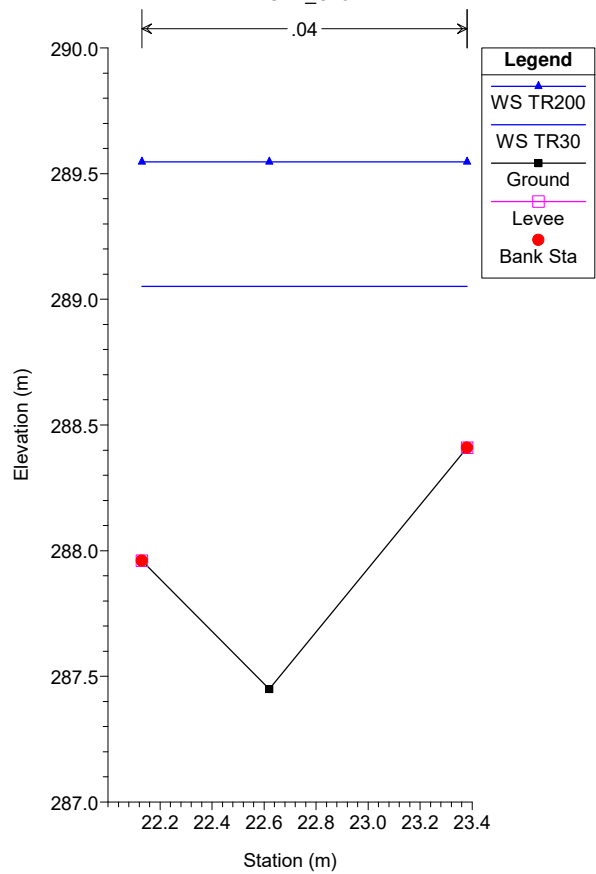

SUD2 Plan: Taratura 05/04/2019
SUD2_C198 (RC_10)

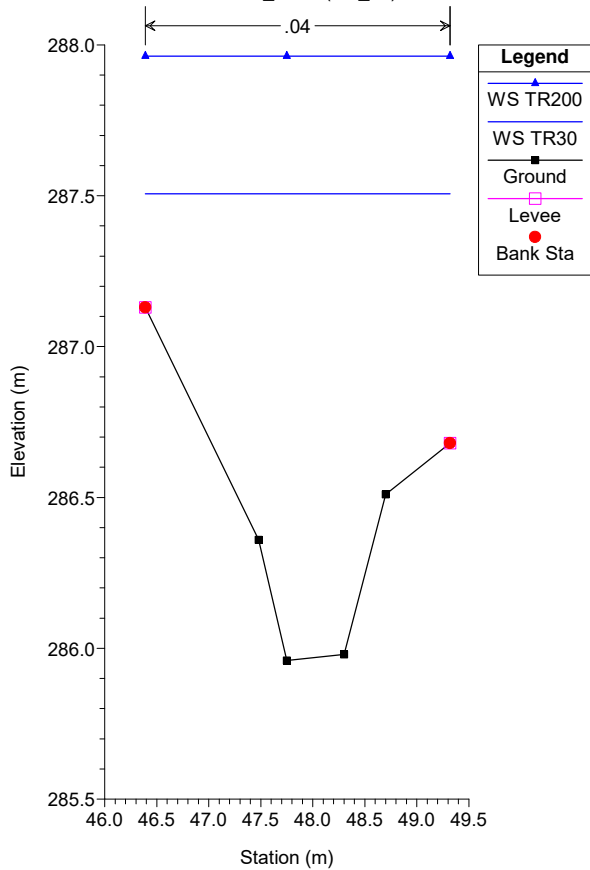

SUD2 Plan: Taratura 05/04/2019
SUD2_C199 (RC_09)

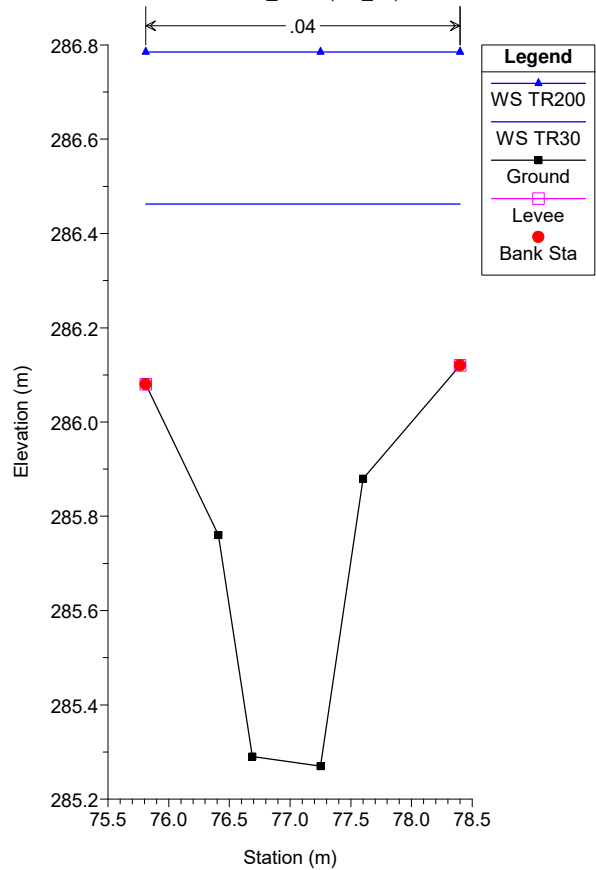

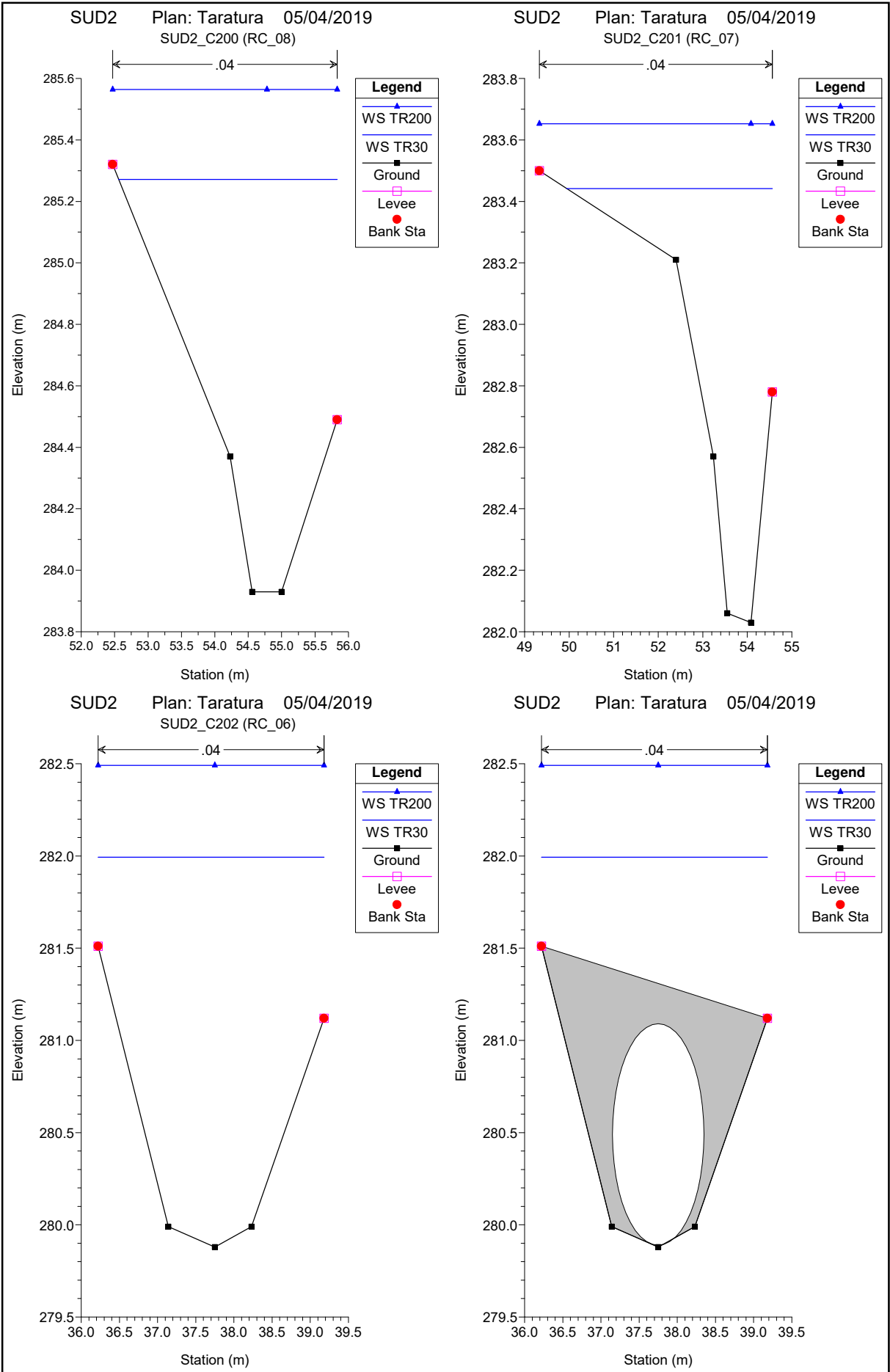

SUD2 Plan: Taratura 05/04/2019

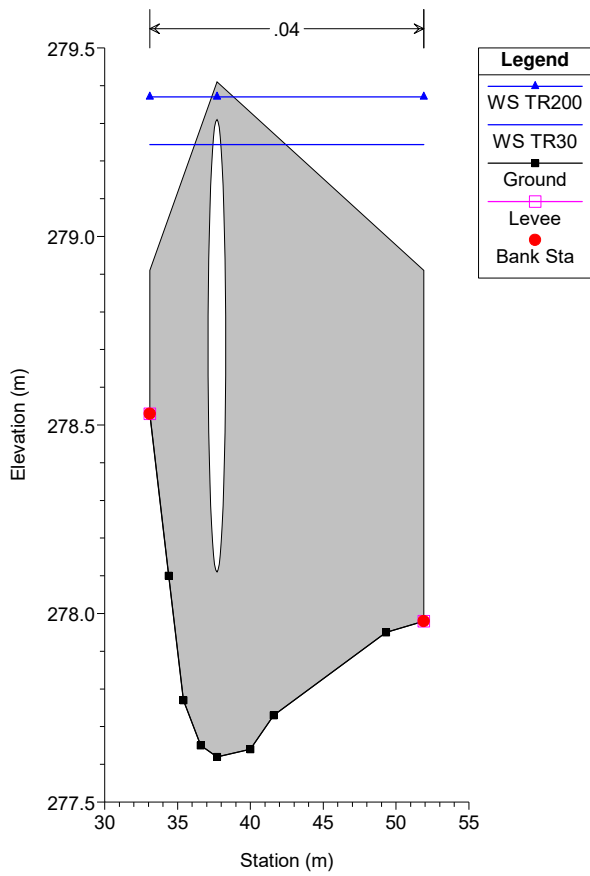

SUD2 Plan: Taratura 05/04/2019
SUD2_C204

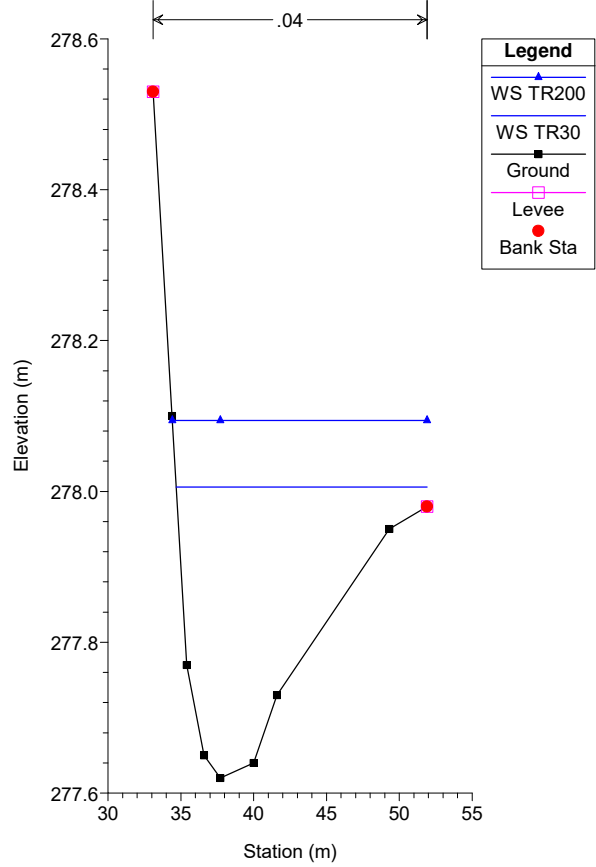

SUD2 Plan: Taratura 05/04/2019
SUD2_C205 (RC_05)

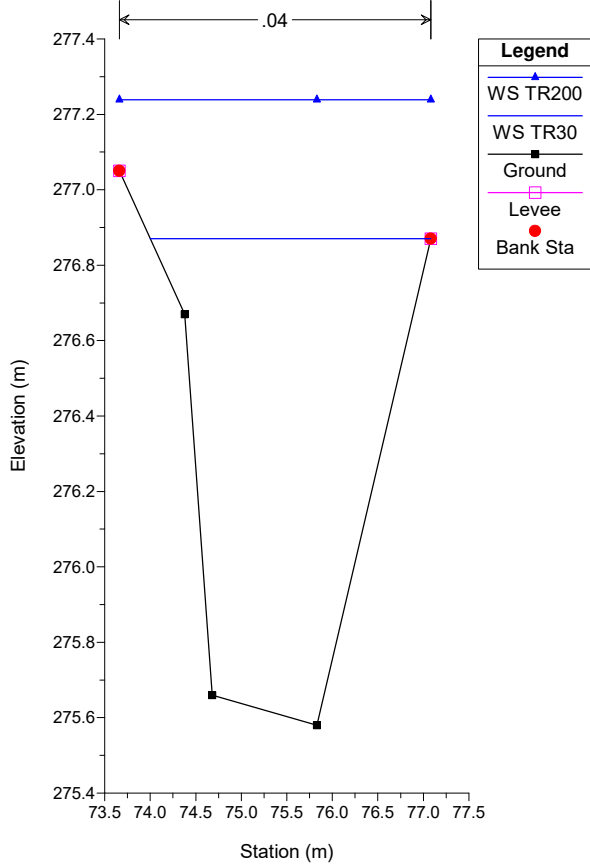

SUD2 Plan: Taratura 05/04/2019
SUD2_C206 (RC_04)

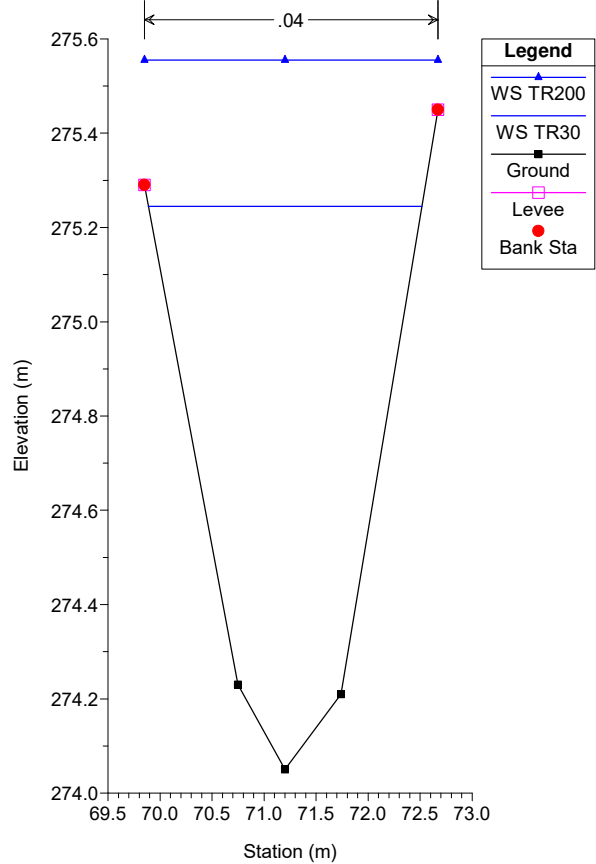

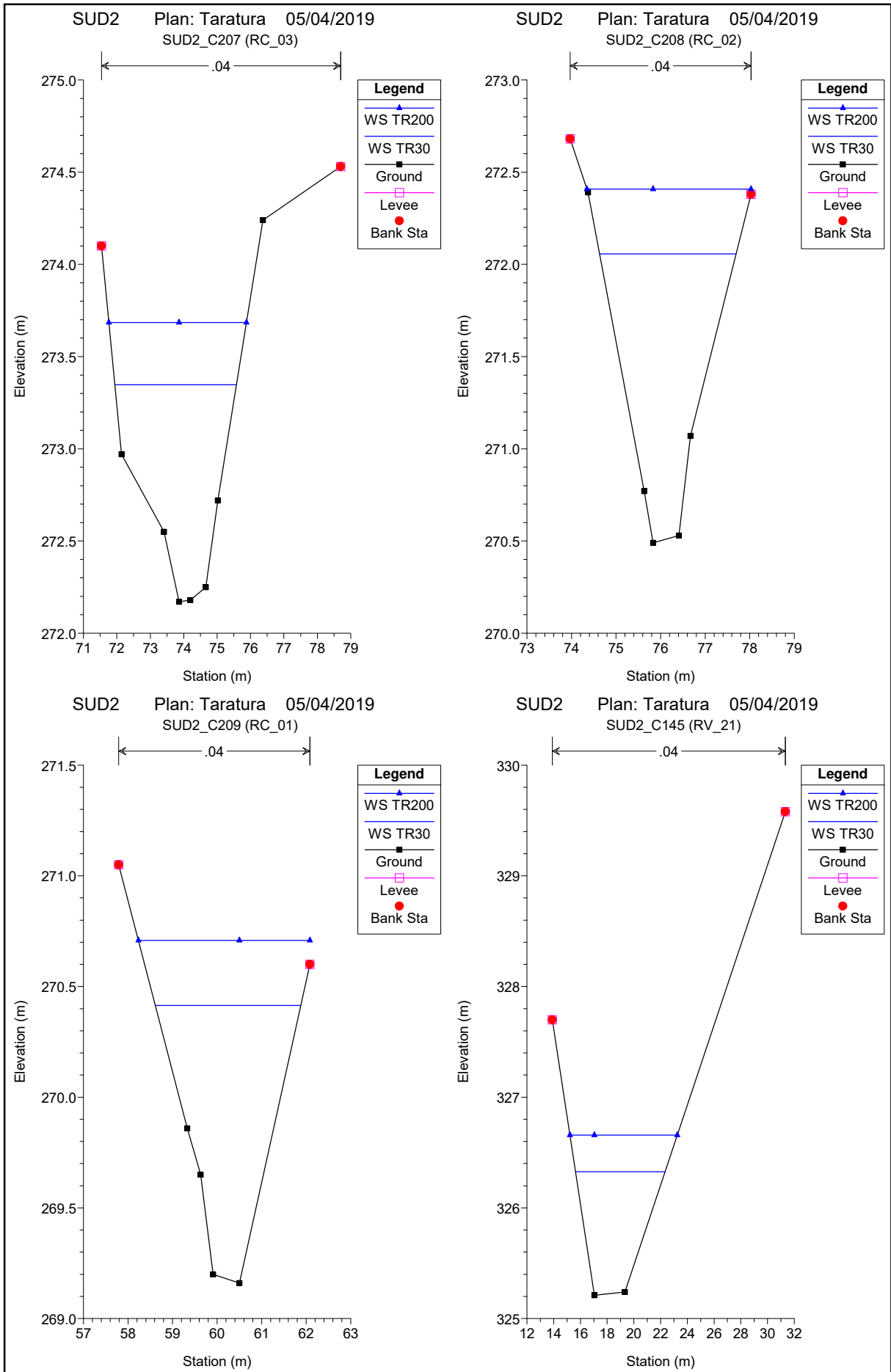

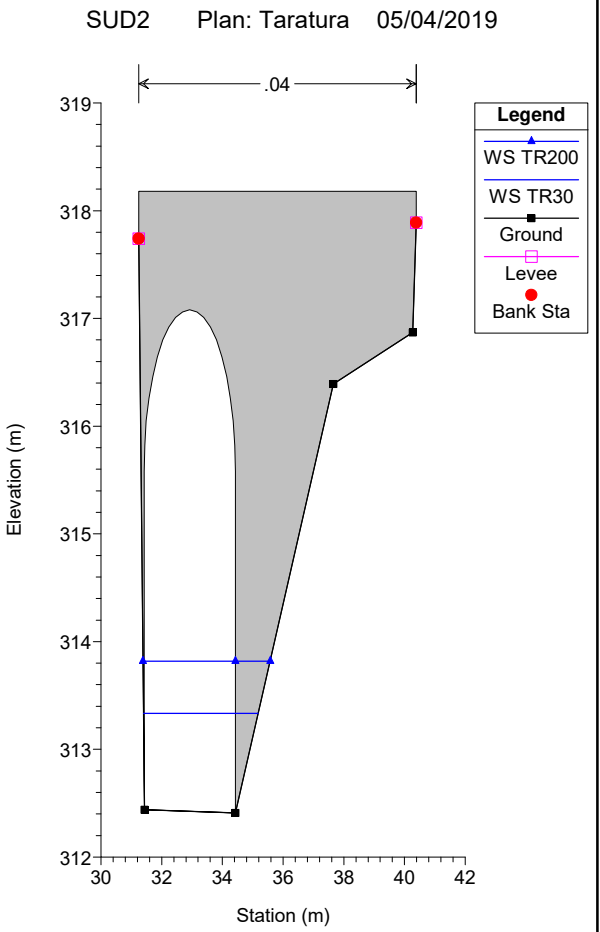
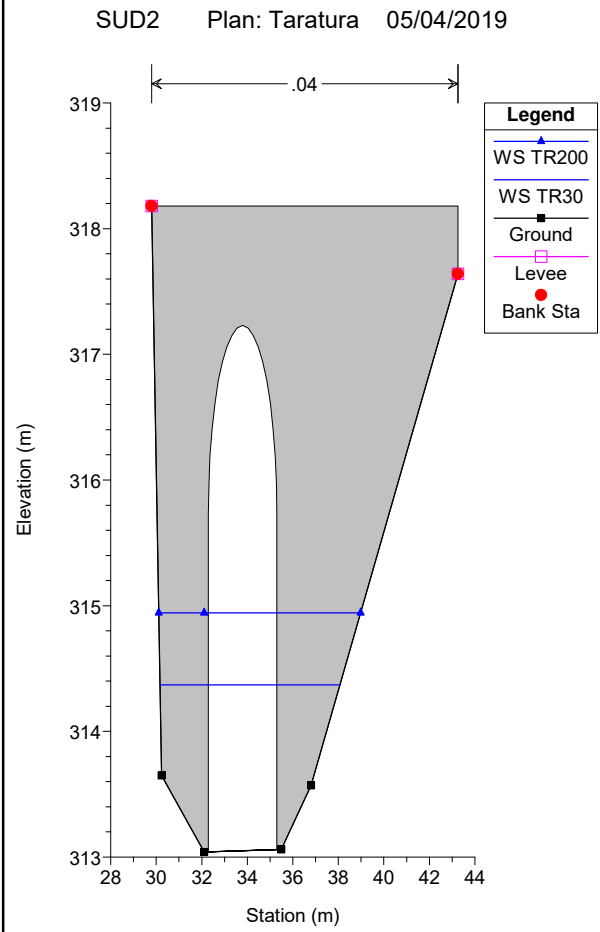
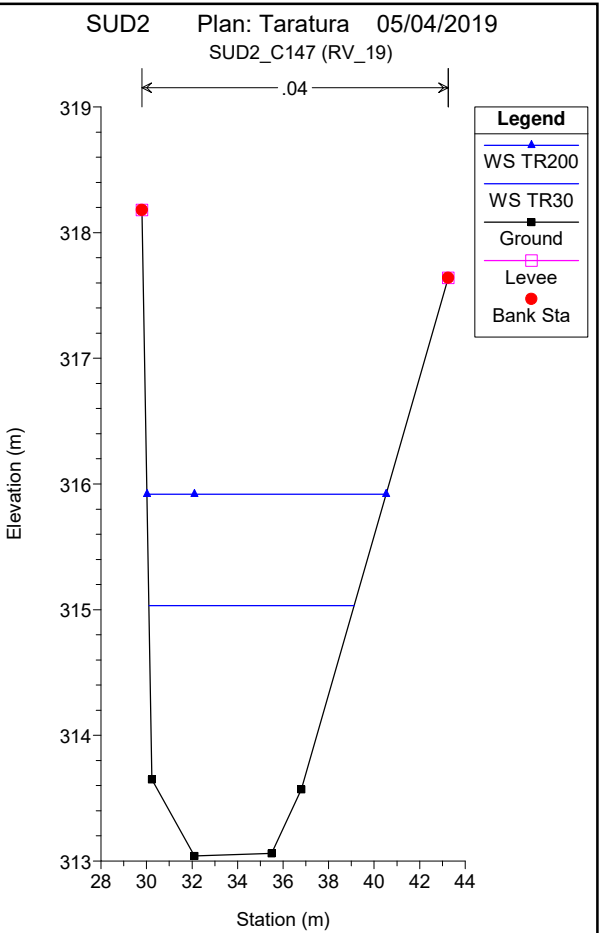
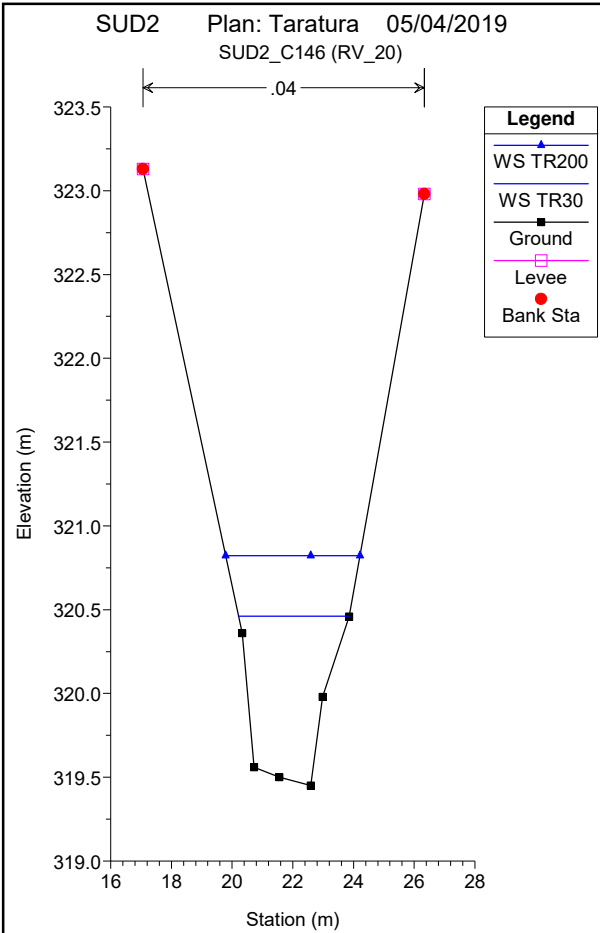

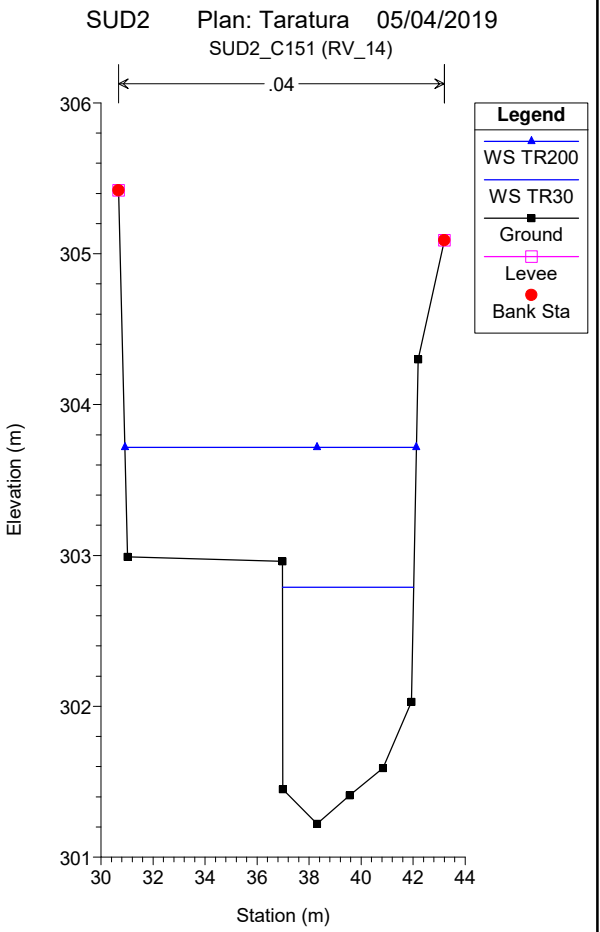
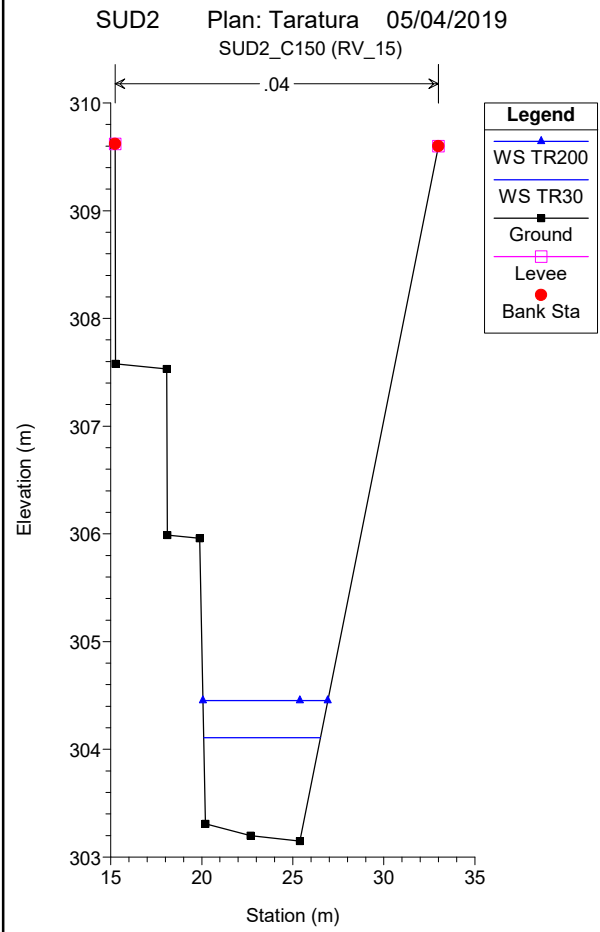
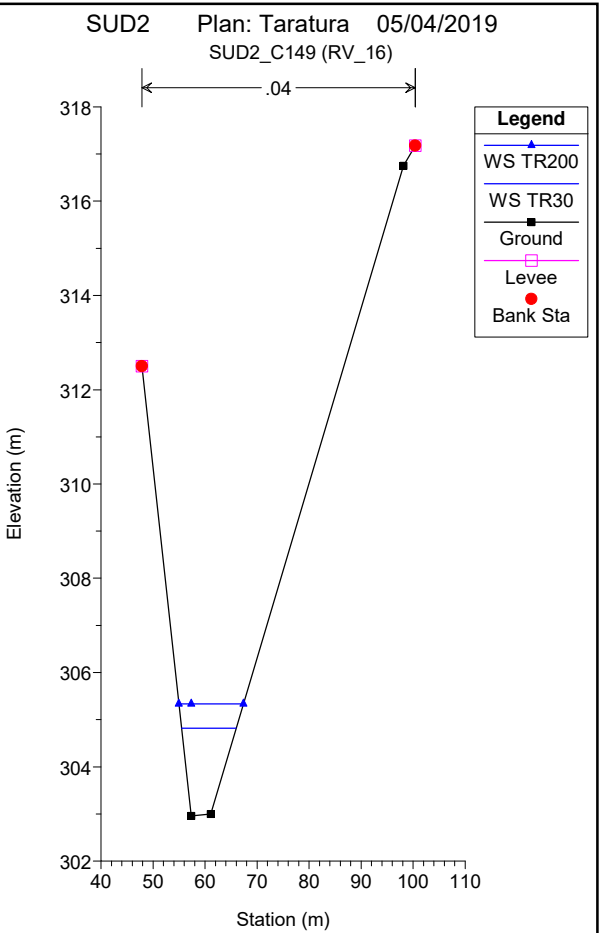
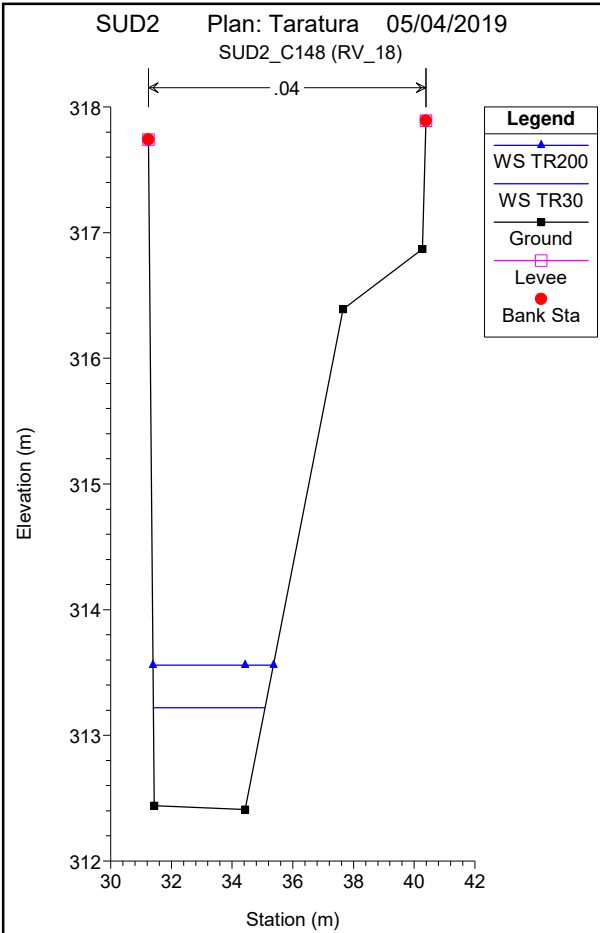

SUD2 Plan: Taratura 05/04/2019

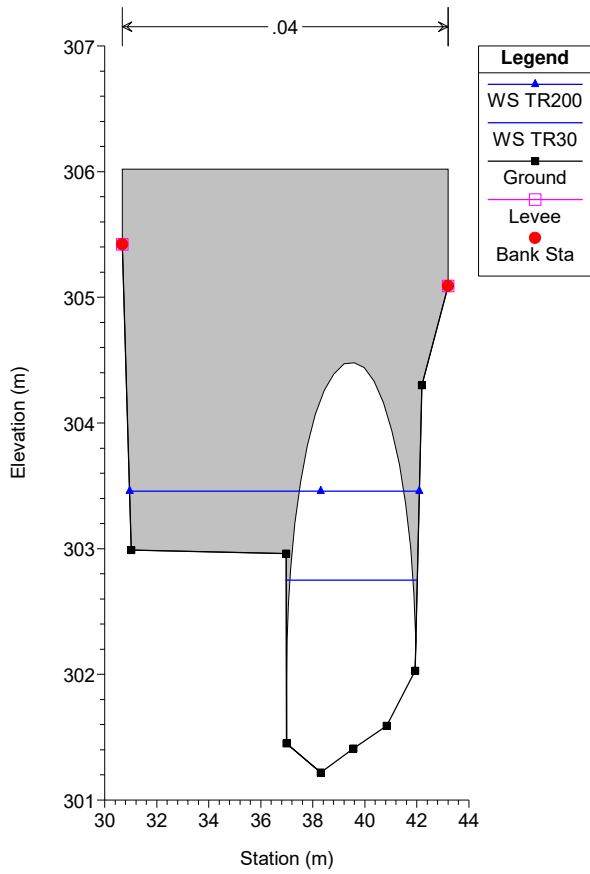

SUD2 Plan: Taratura 05/04/2019

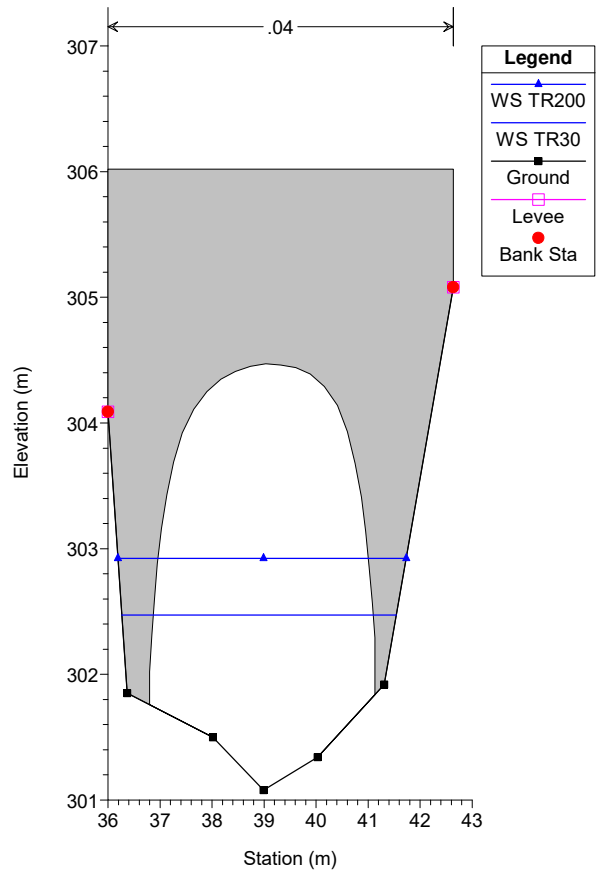

SUD2 Plan: Taratura 05/04/2019
SUD2_C152 (RV_13)

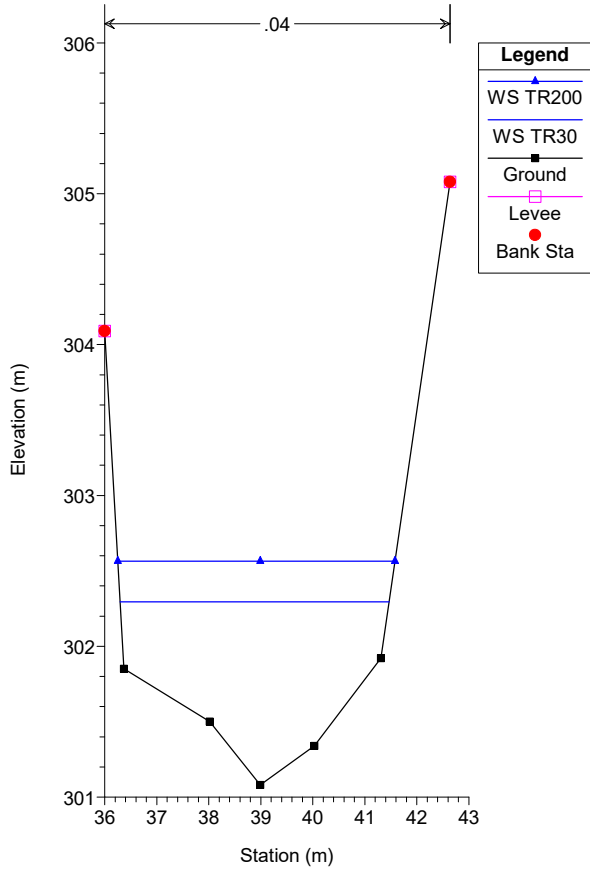

SUD2 Plan: Taratura 05/04/2019
SUD2_C153 (RV_12)

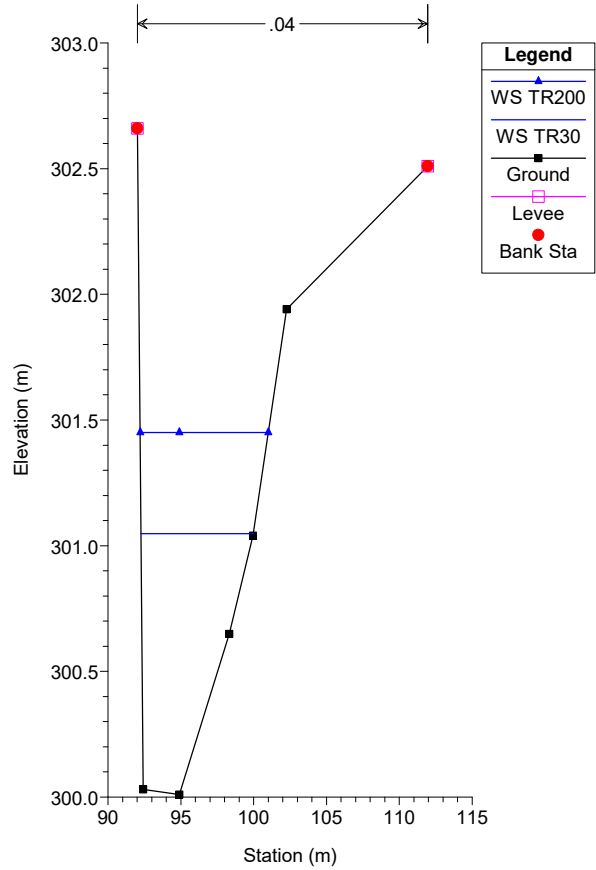

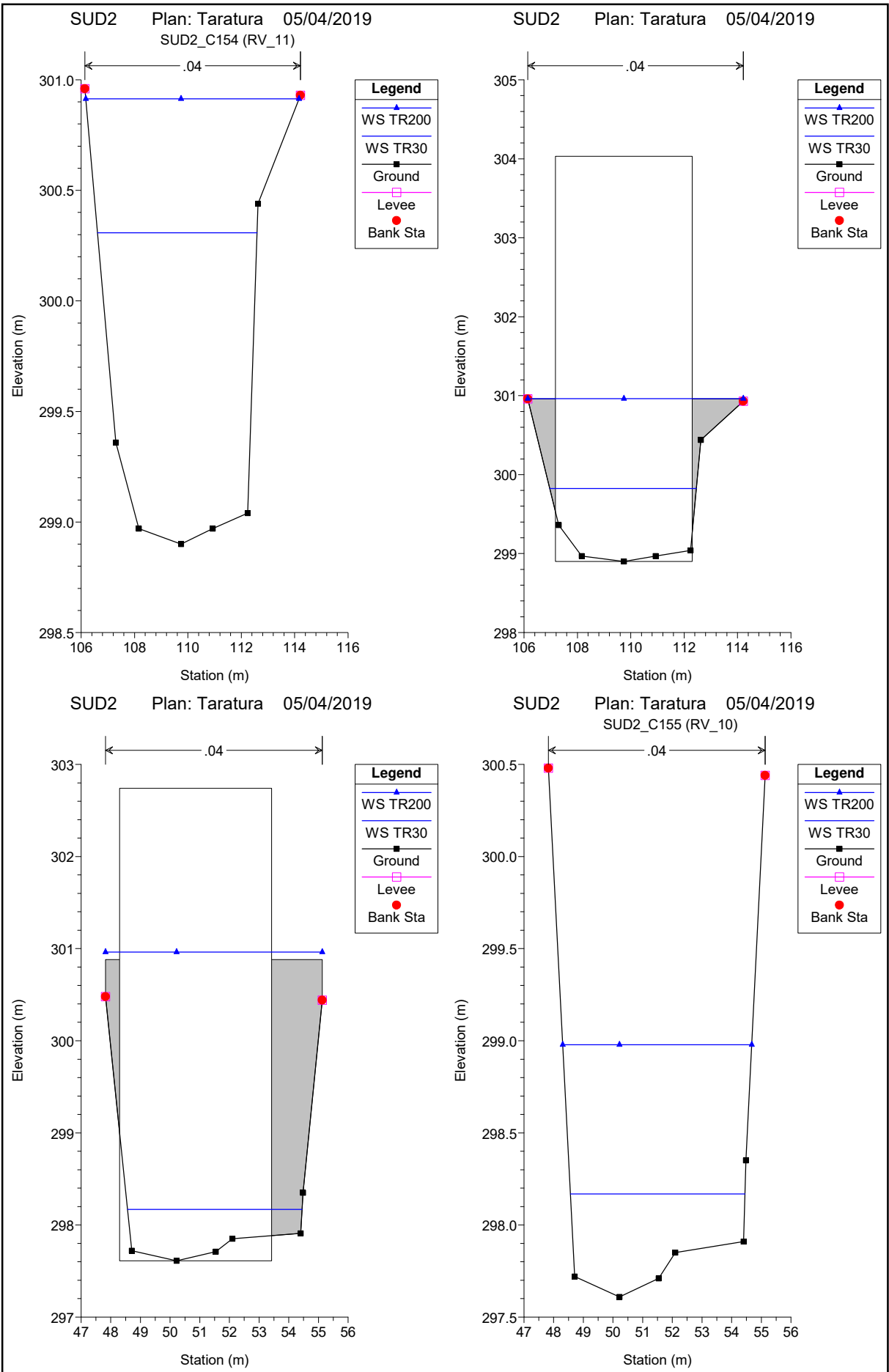

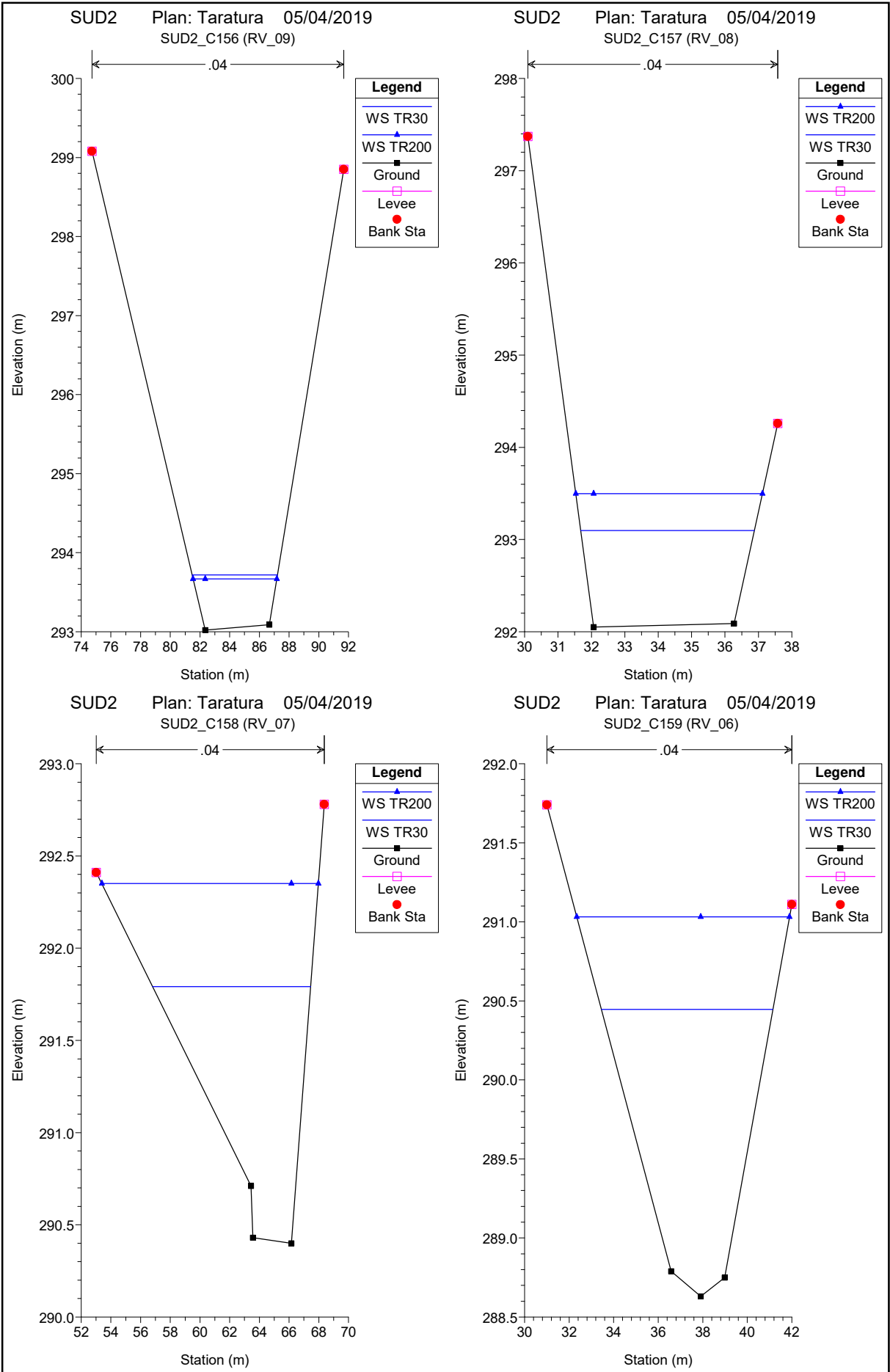

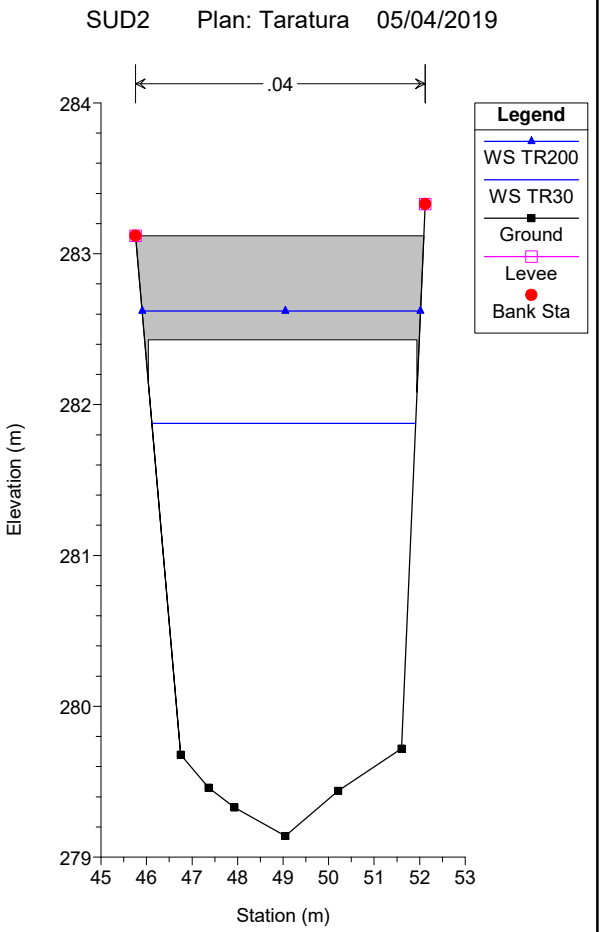
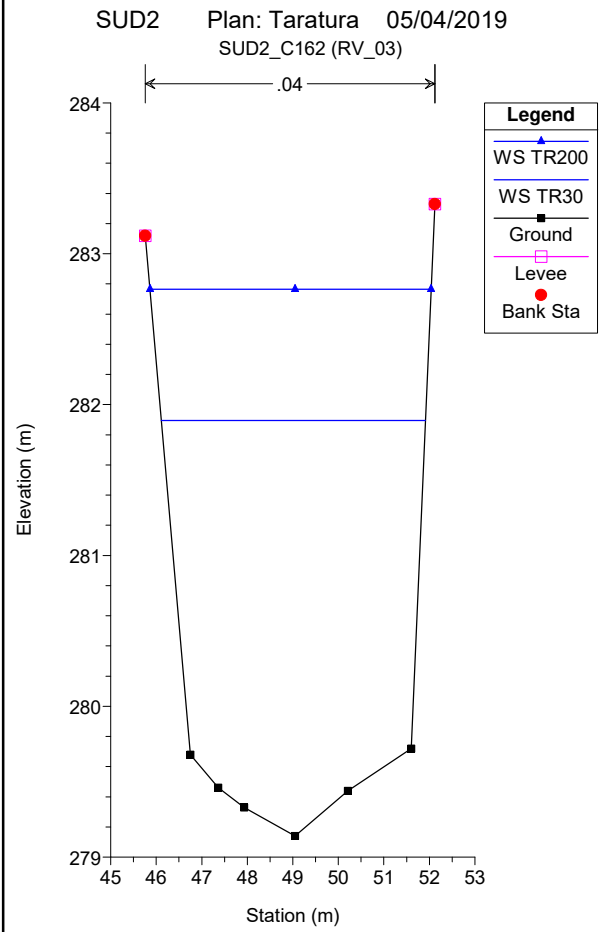
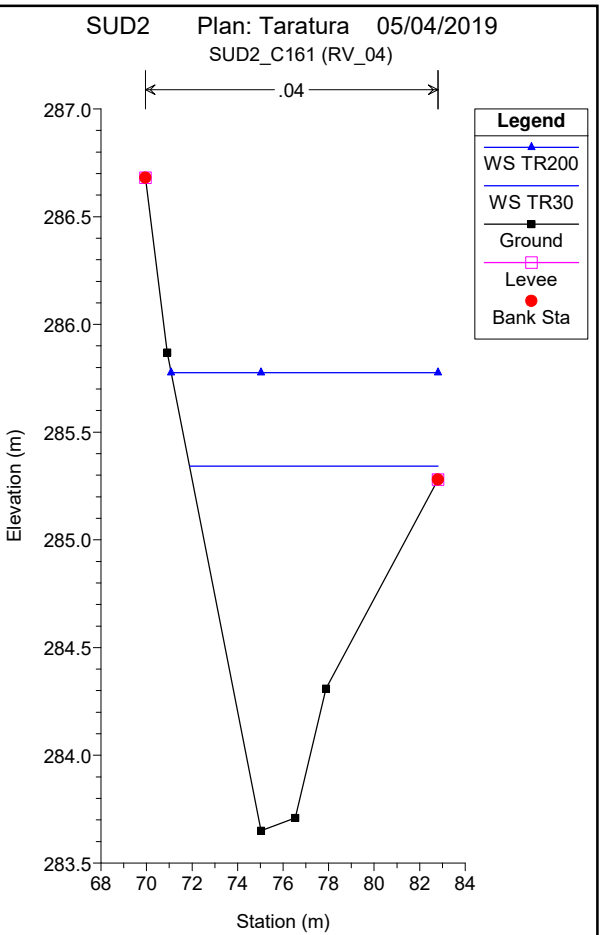
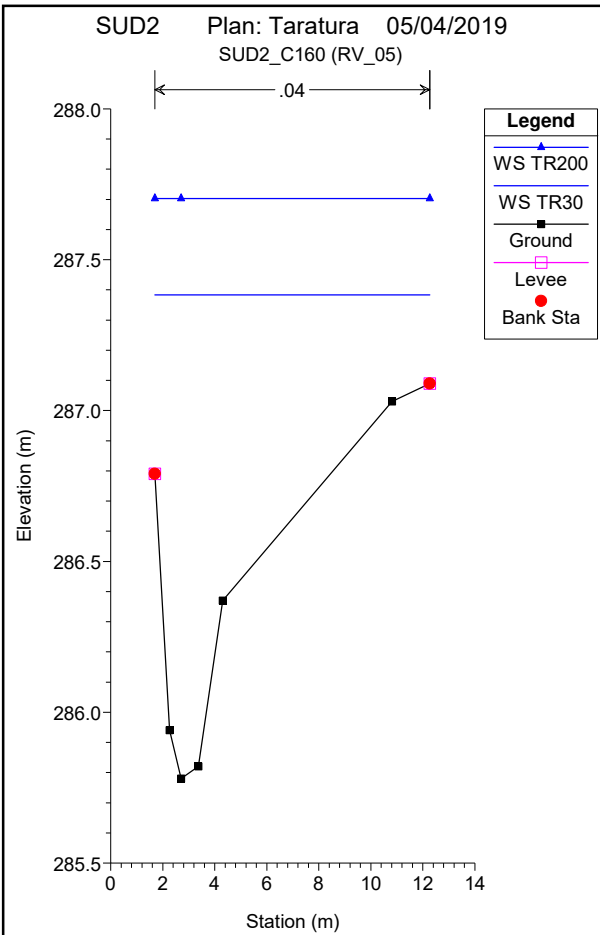

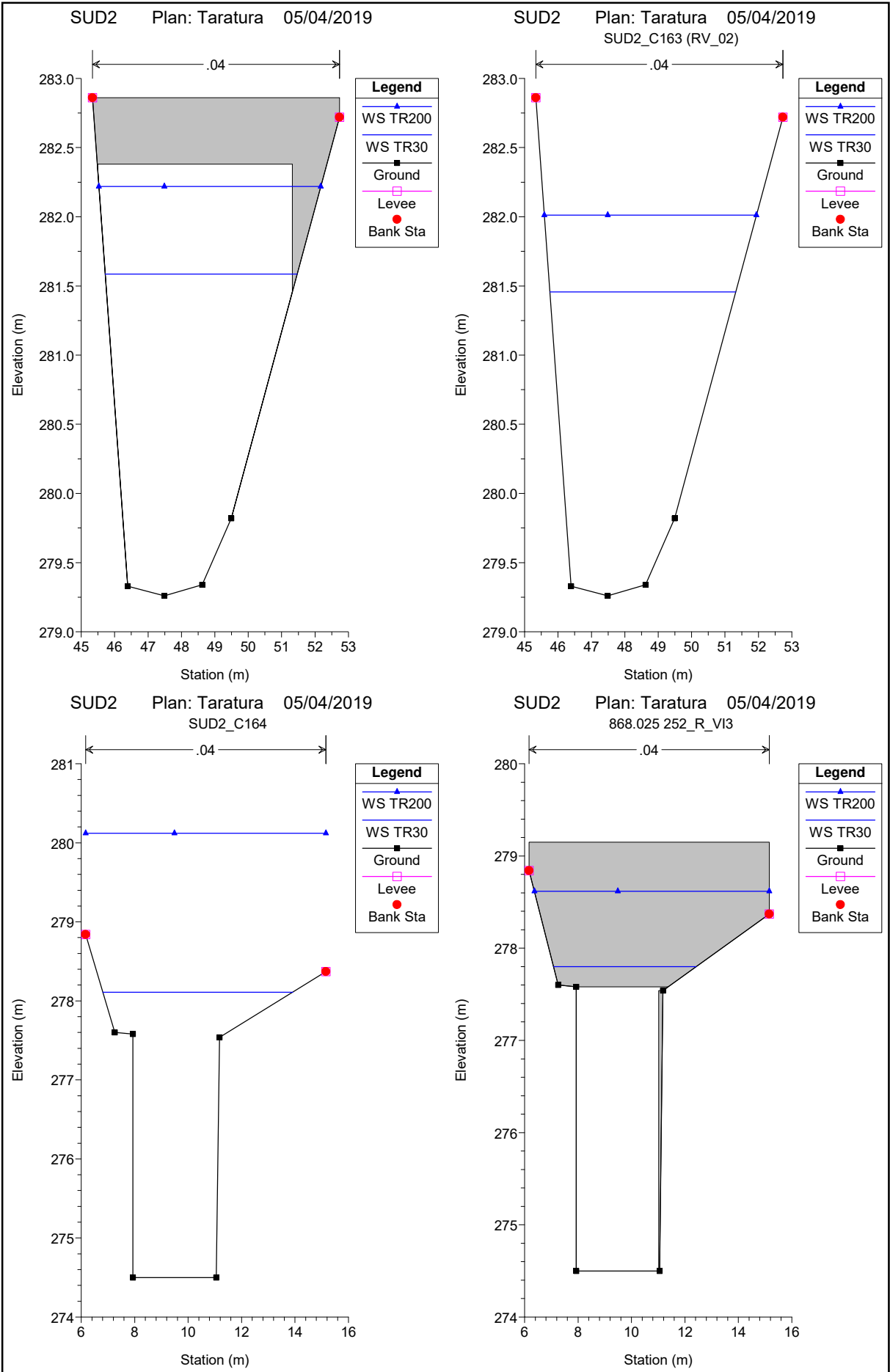

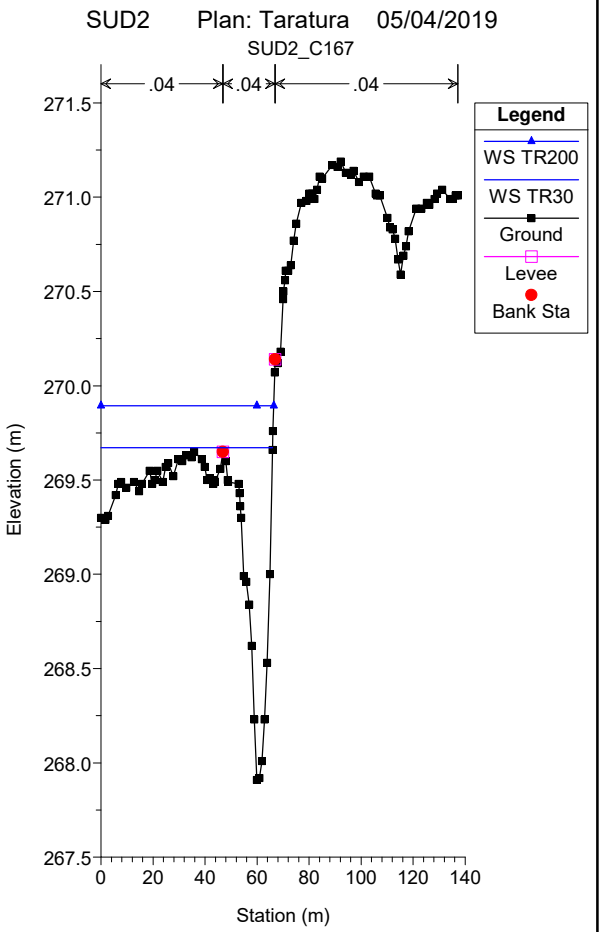
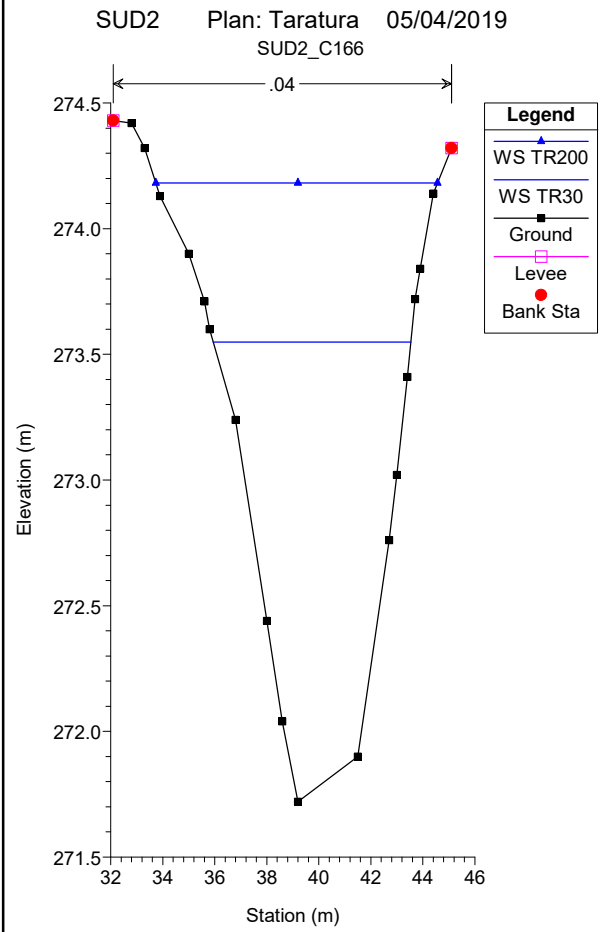
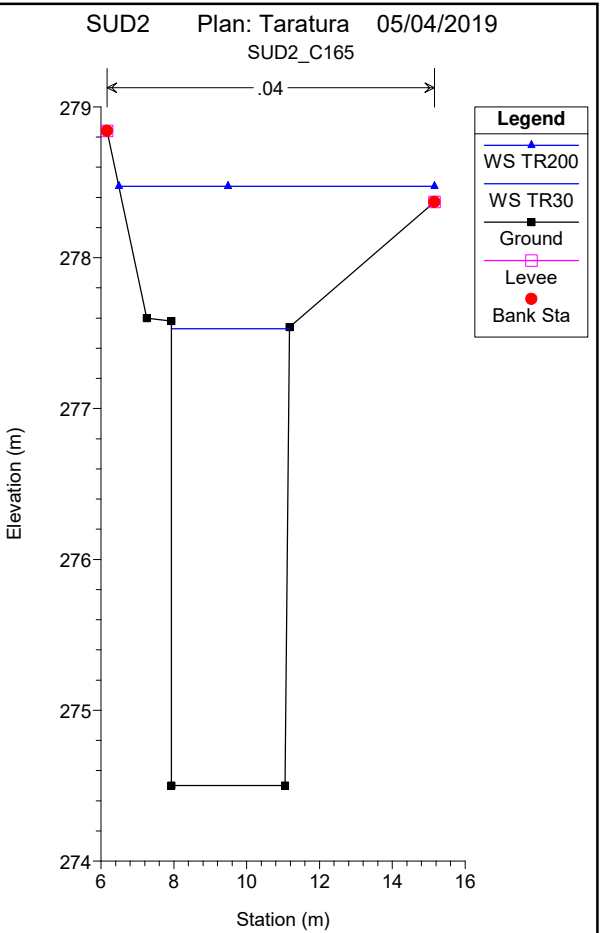
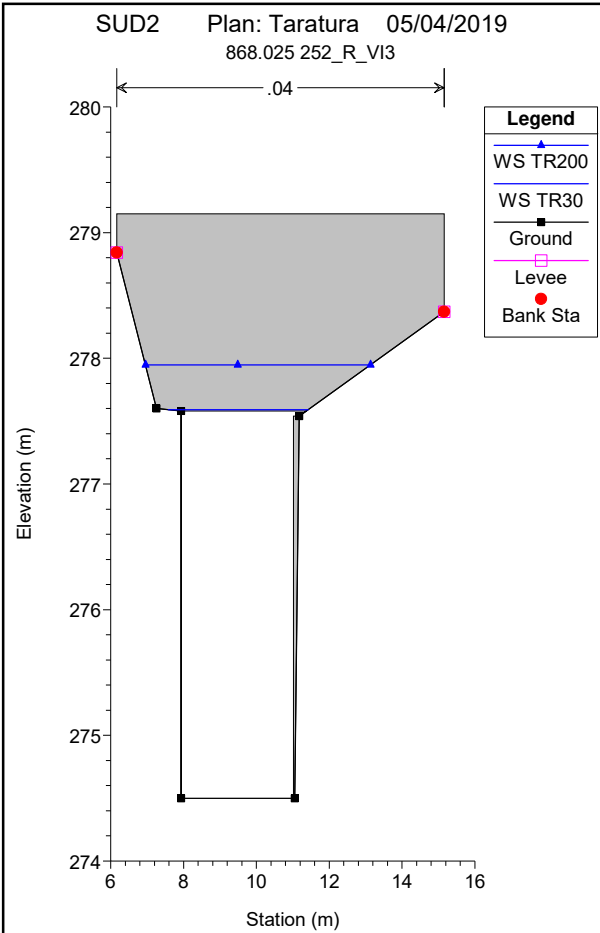

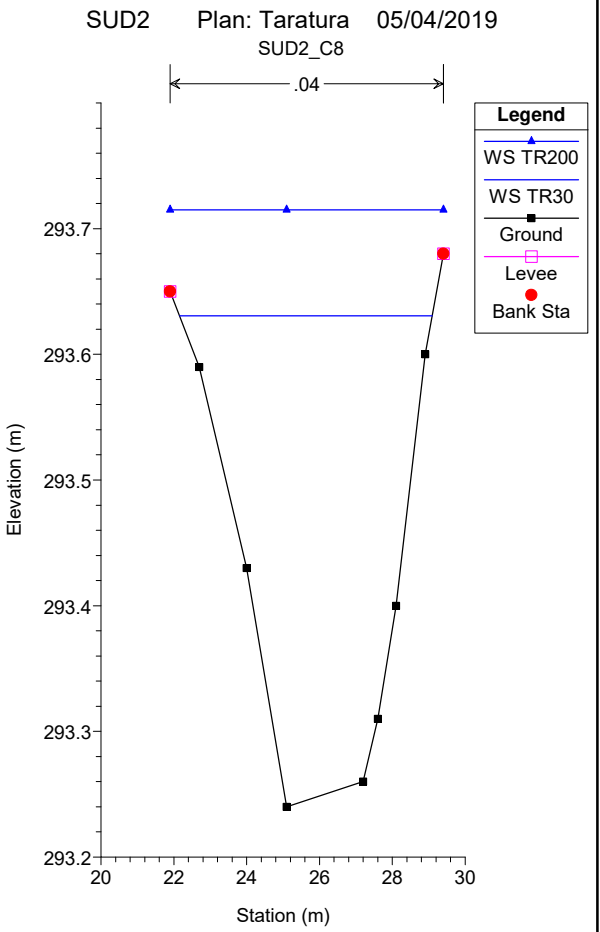
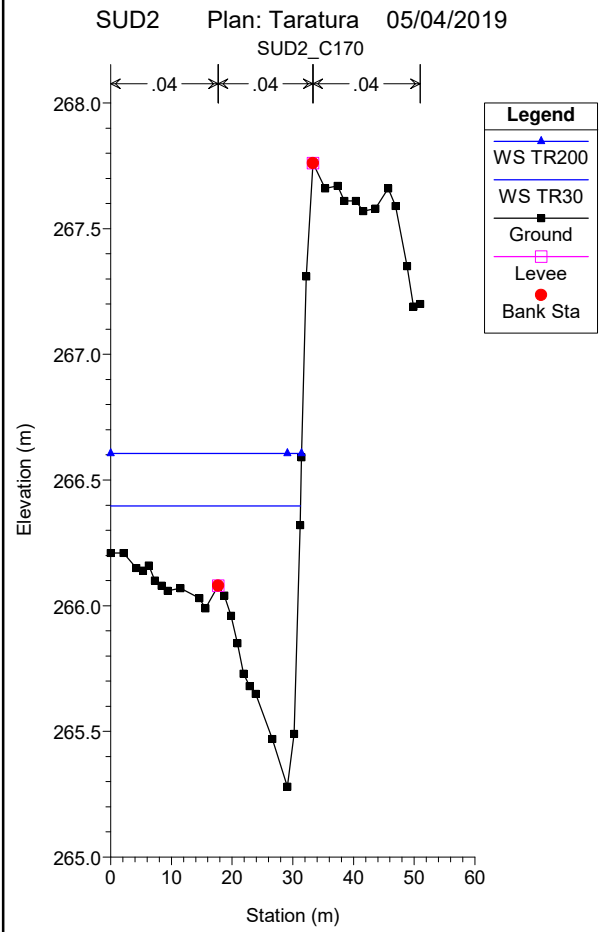
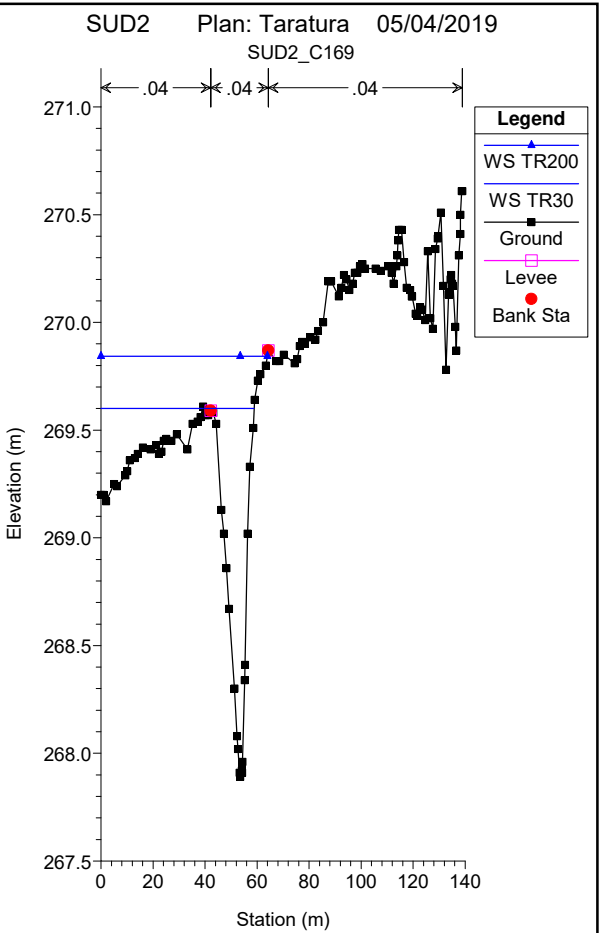
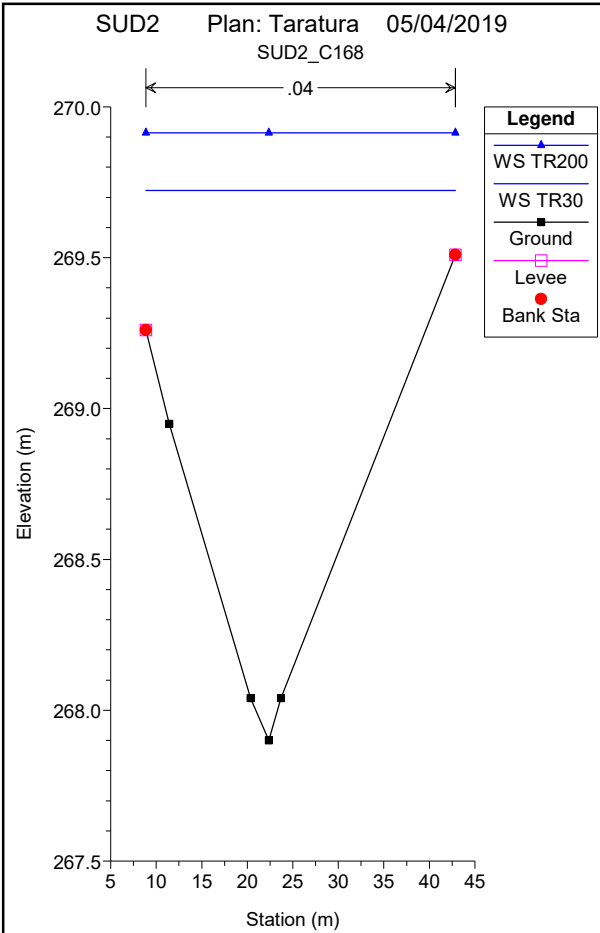

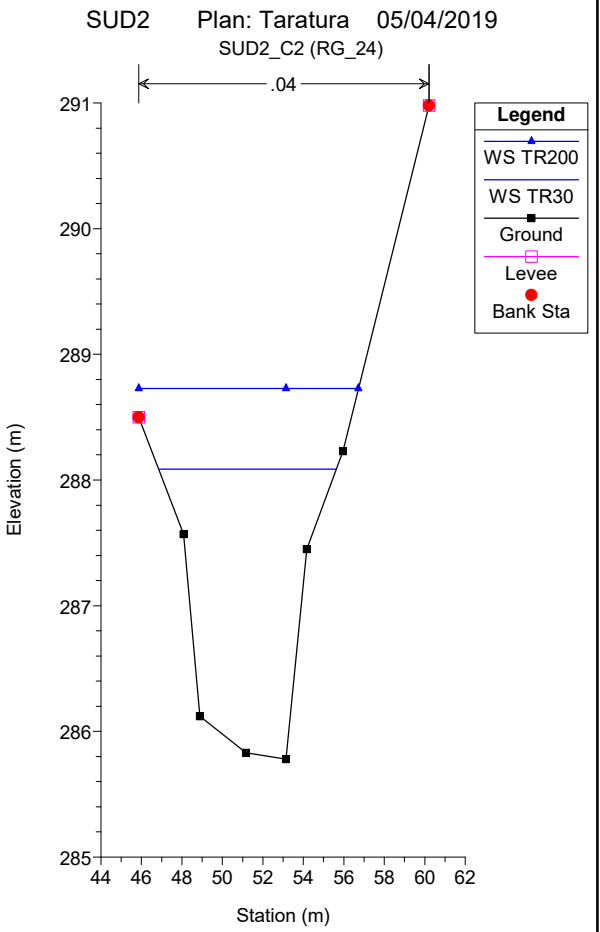
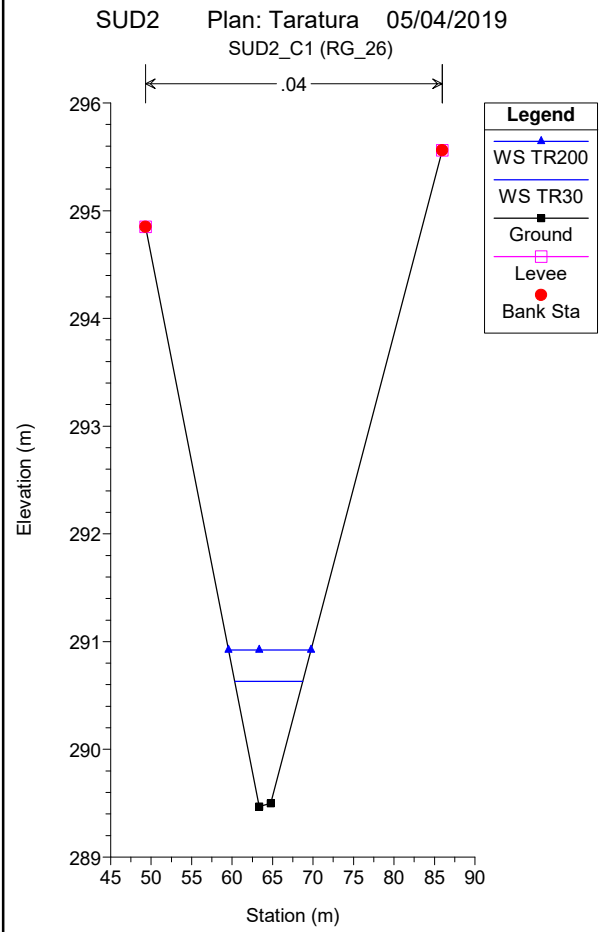
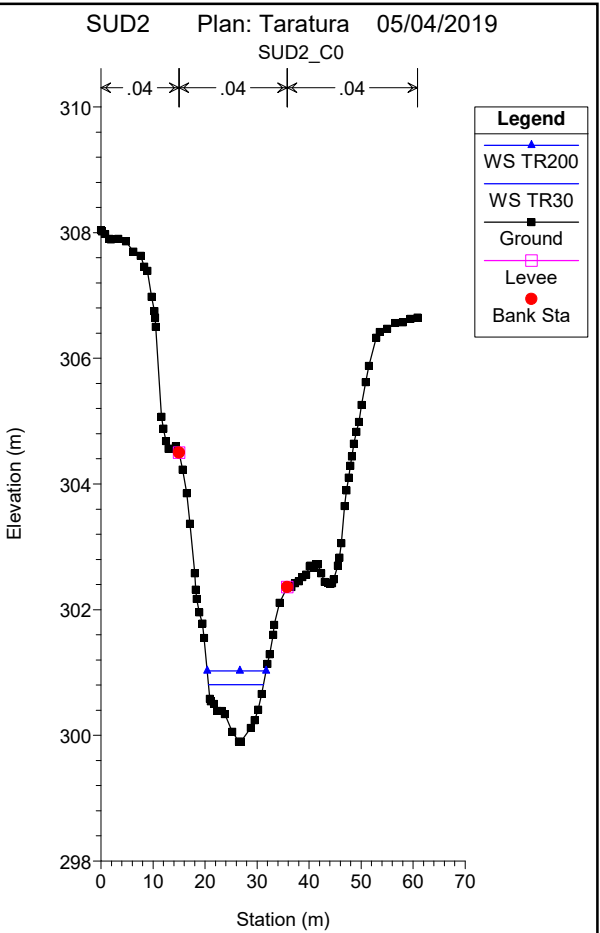
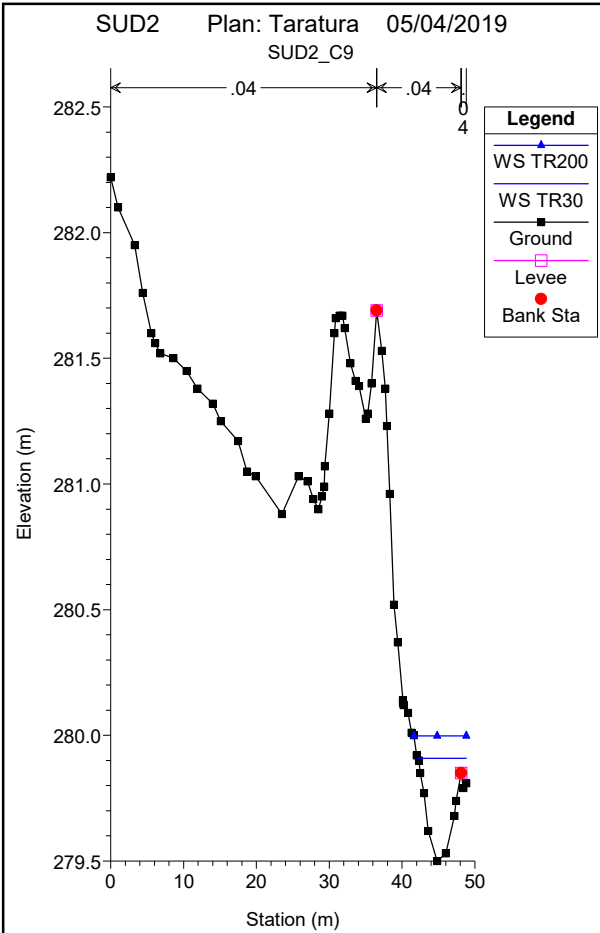

SUD2 Plan: Taratura 05/04/2019

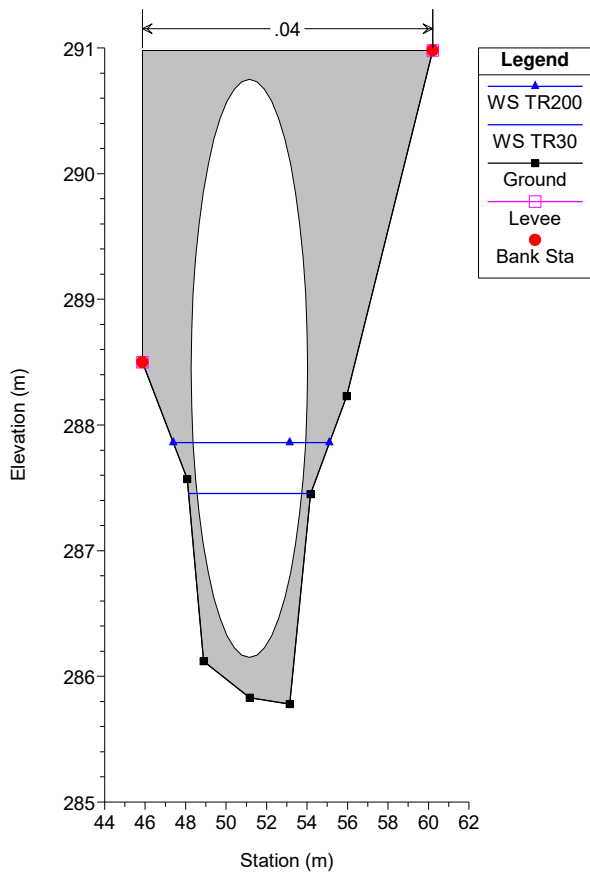

SUD2 Plan: Taratura 05/04/2019

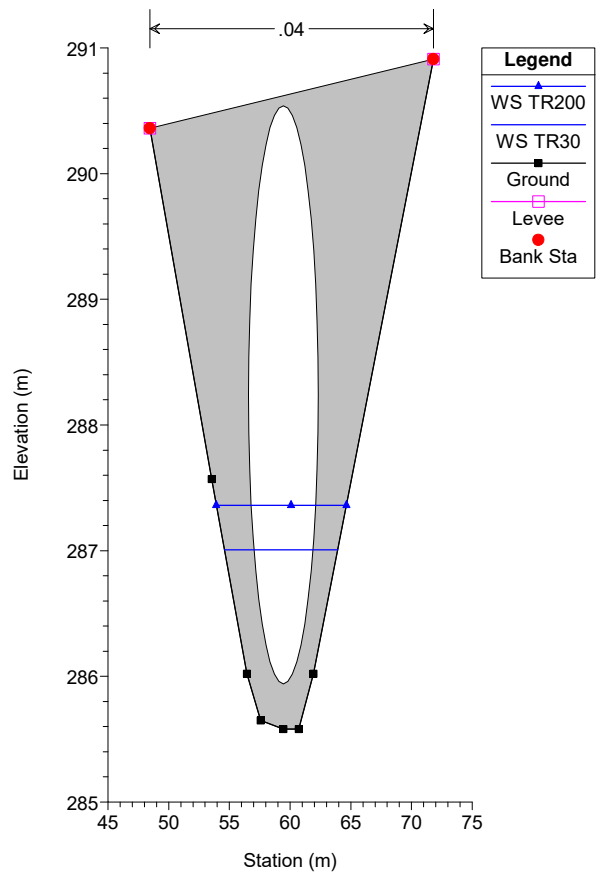

SUD2 Plan: Taratura 05/04/2019
SUD2_C3 (RG_24A)

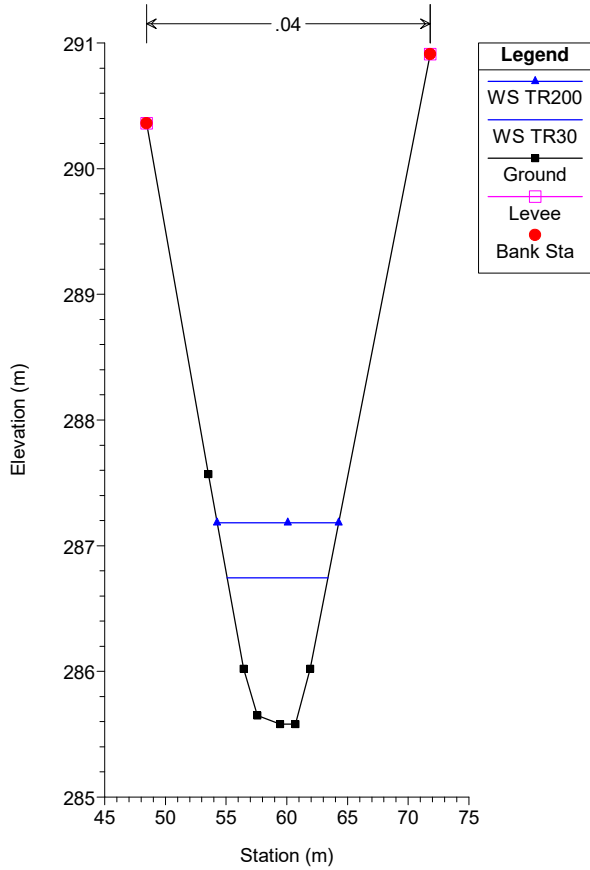

SUD2 Plan: Taratura 05/04/2019
SUD2_C4 (RG_23)

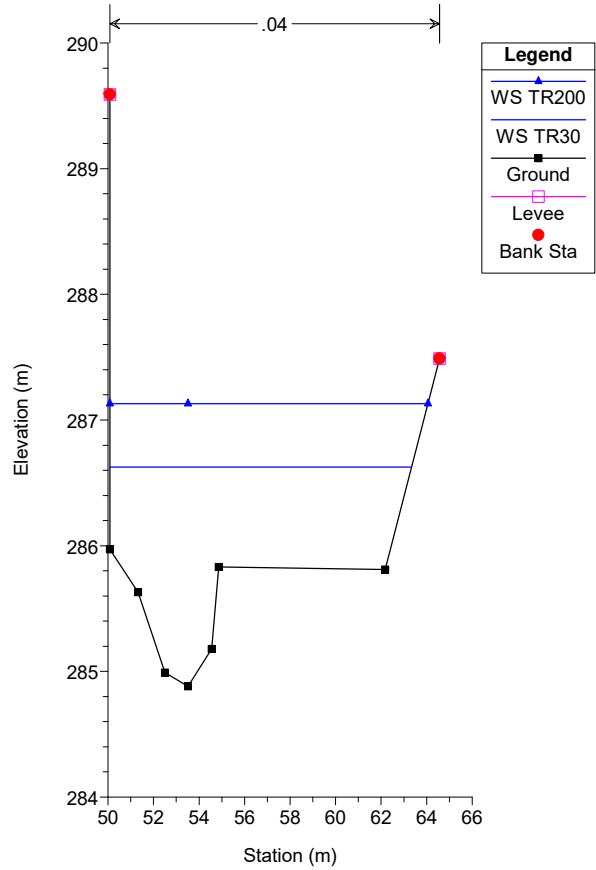

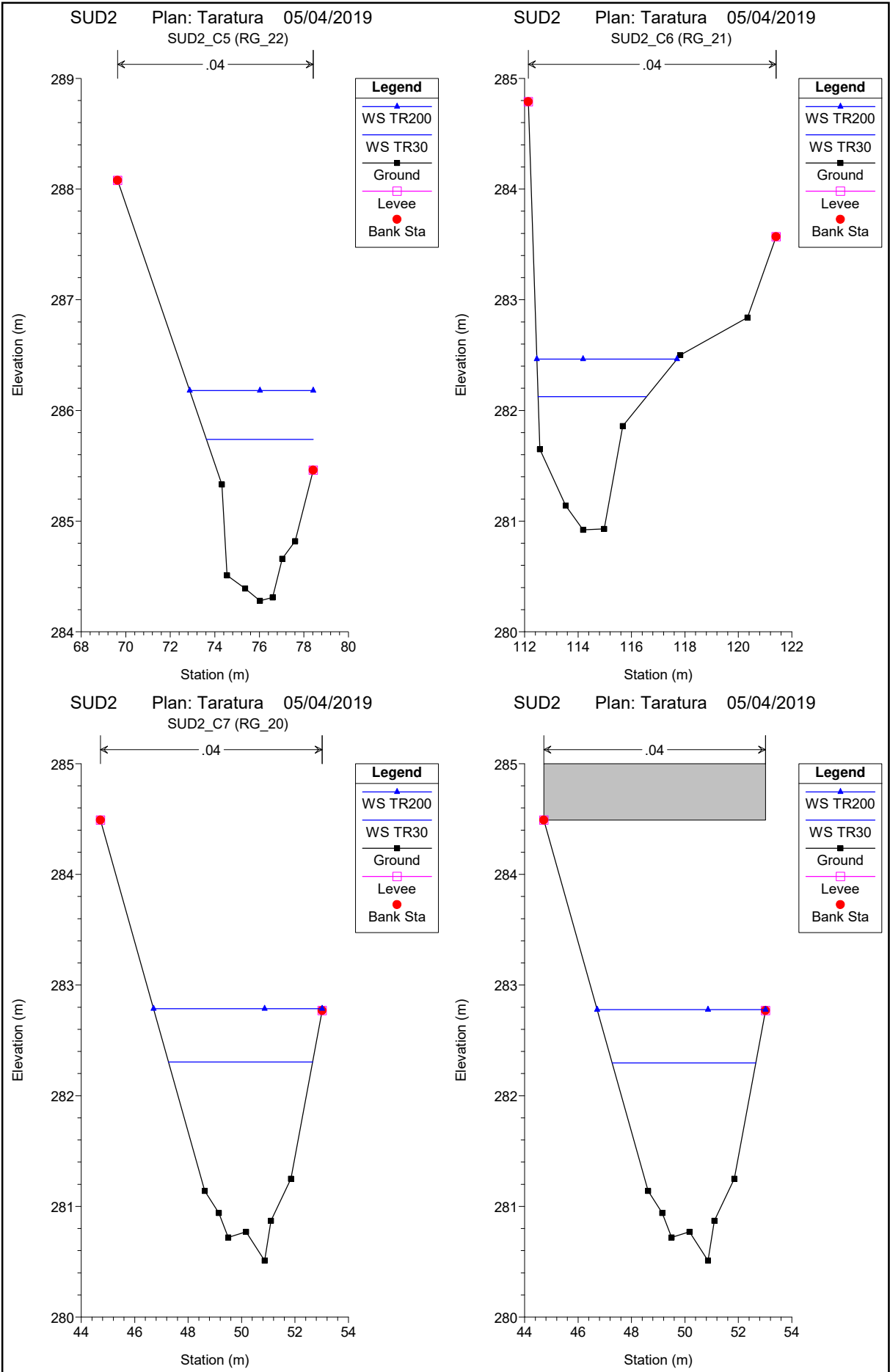

SUD2 Plan: Taratura 05/04/2019

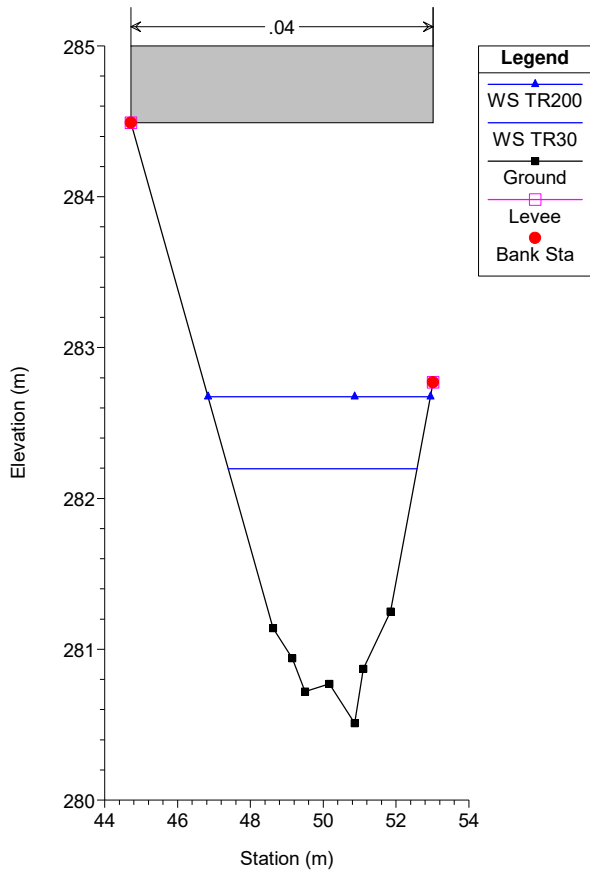

SUD2 Plan: Taratura 05/04/2019
SUD2_C7

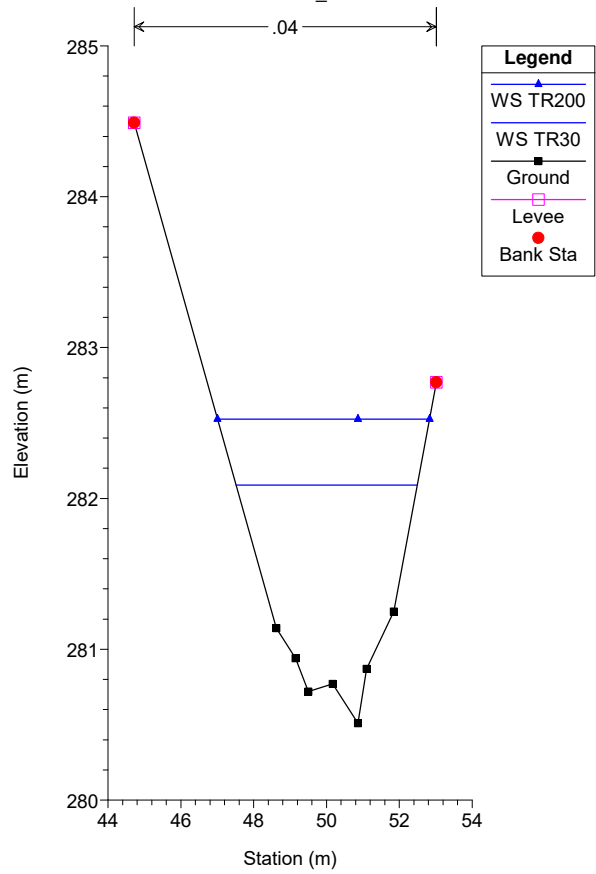

SUD2 Plan: Taratura 05/04/2019
SUD2_C95 (RG_18)

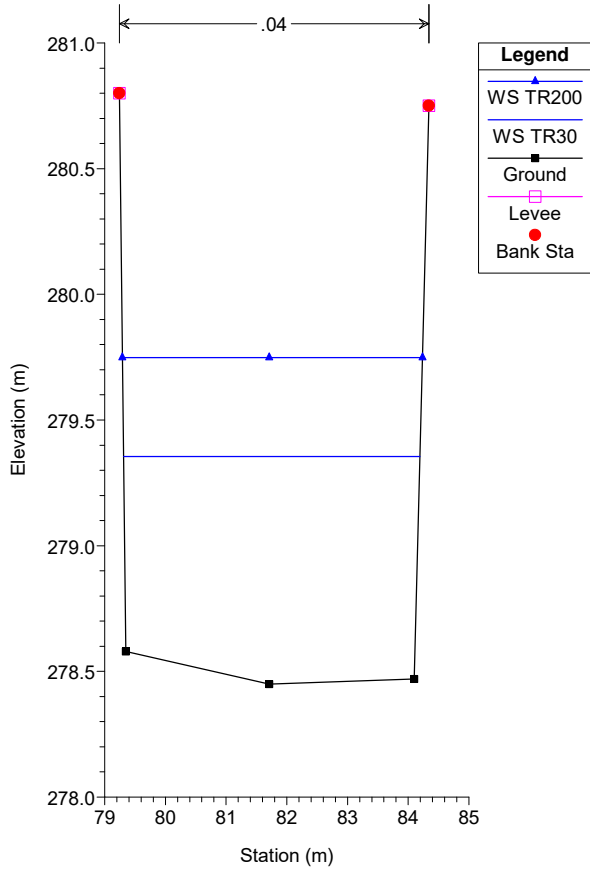

SUD2 Plan: Taratura 05/04/2019

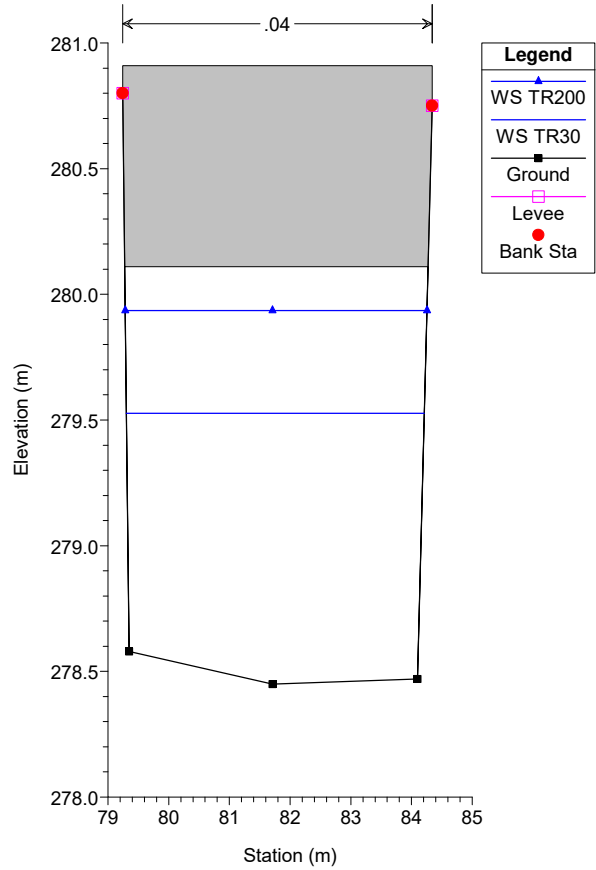

SUD2 Plan: Taratura 05/04/2019

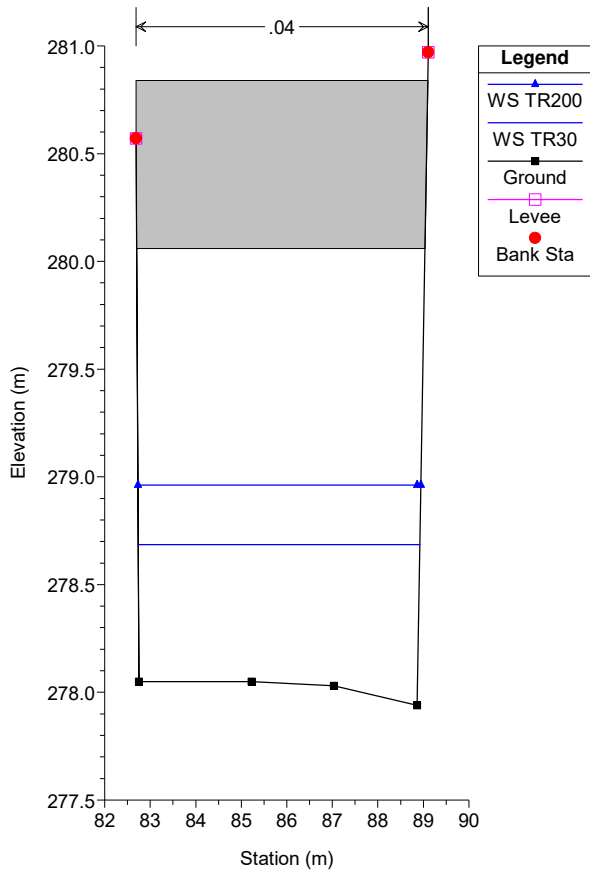

SUD2 Plan: Taratura 05/04/2019
SUD2_C96 (RG_17)

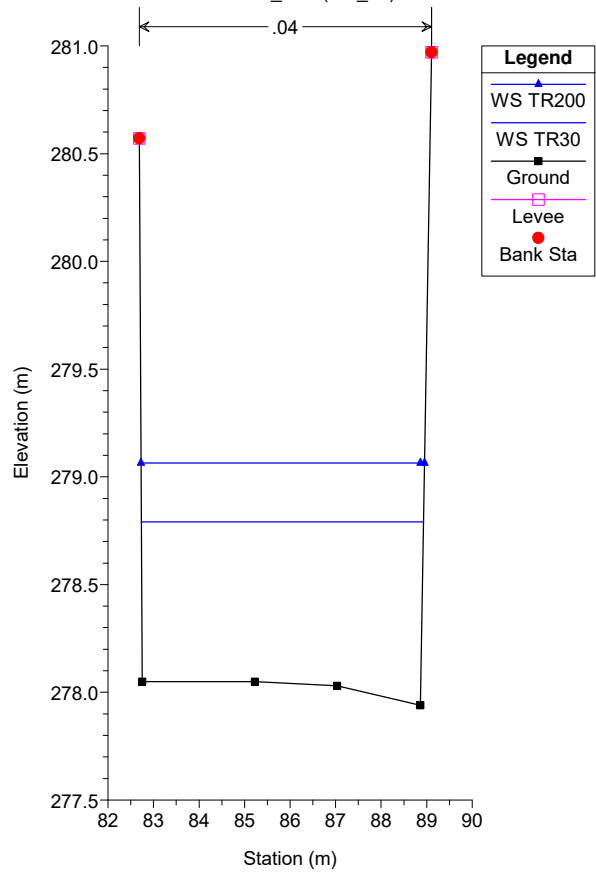

SUD2 Plan: Taratura 05/04/2019
SUD2_C97 (RG_16)

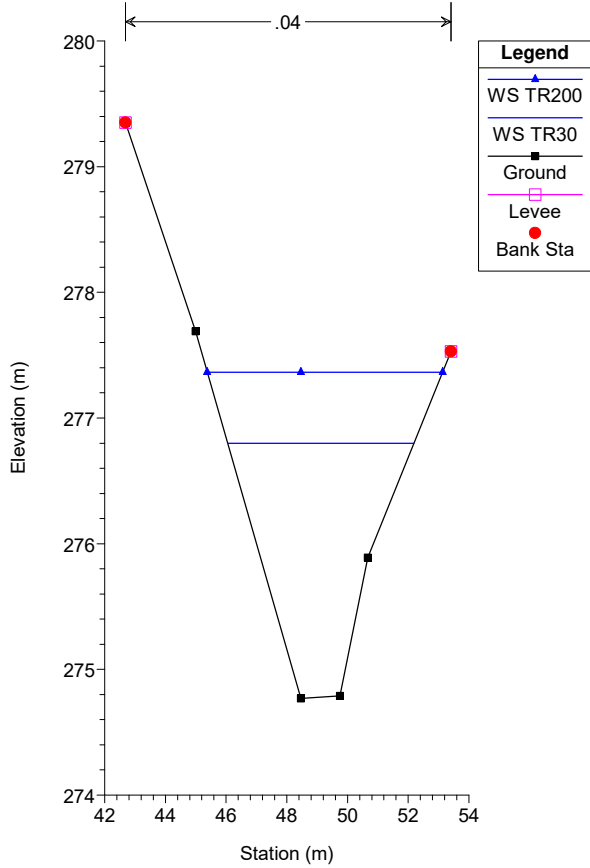

SUD2 Plan: Taratura 05/04/2019
SUD2_C98 (RG_15)

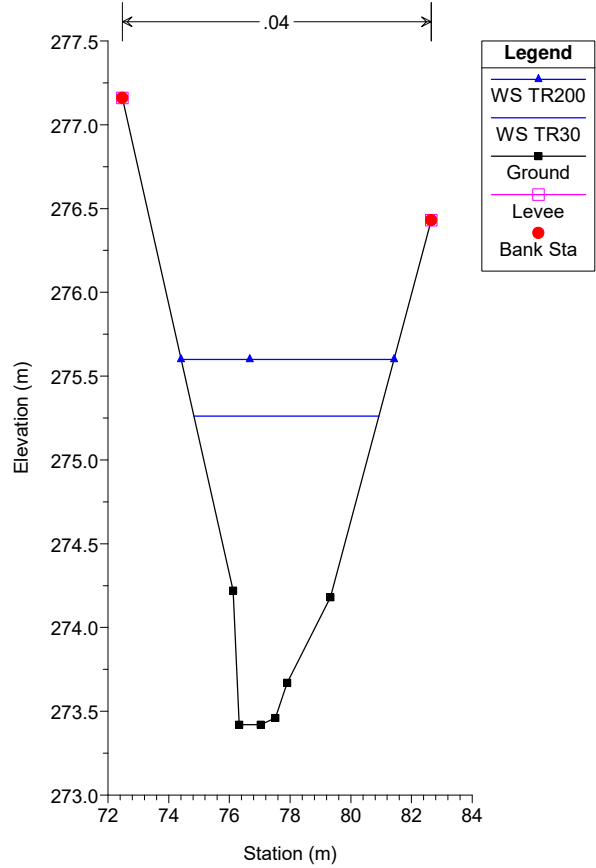

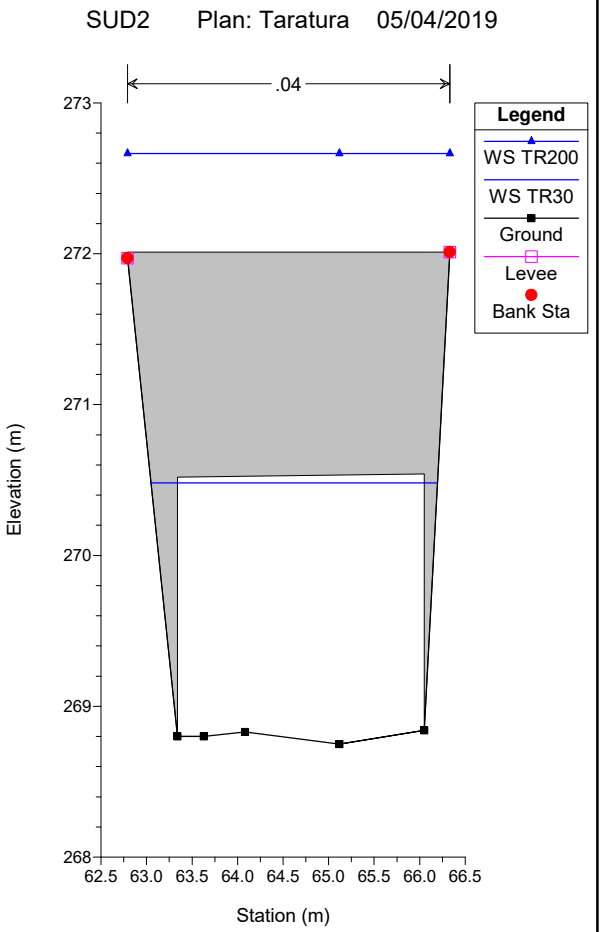
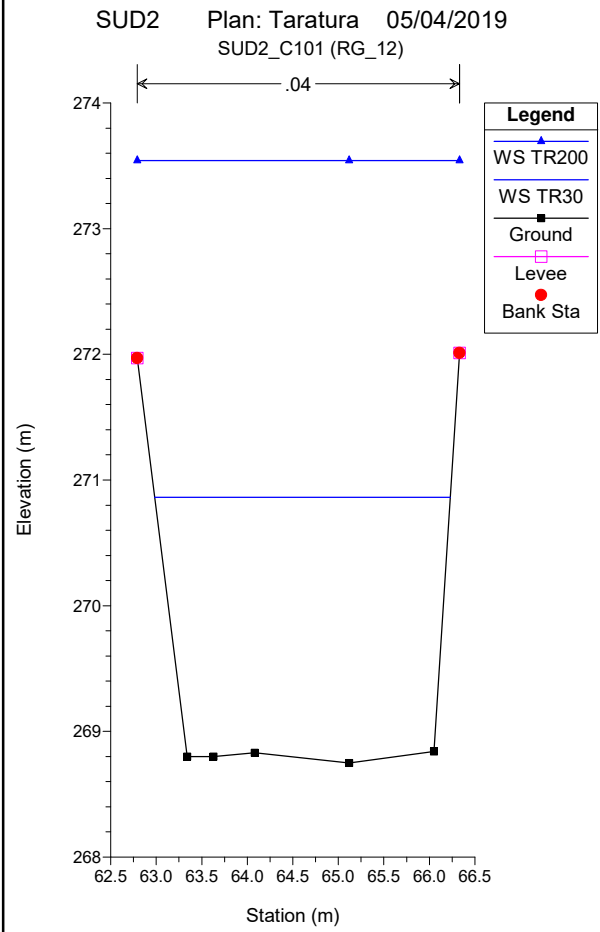
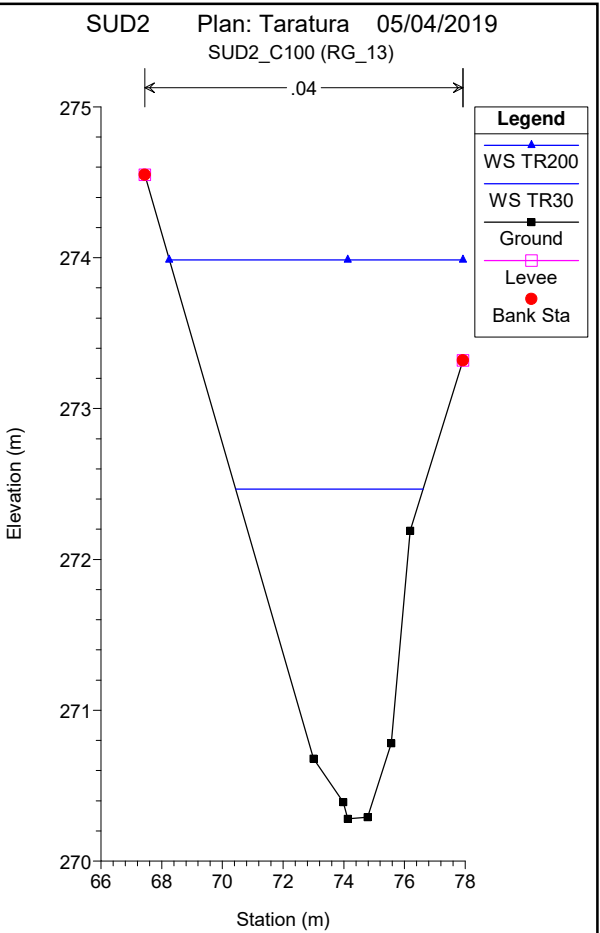
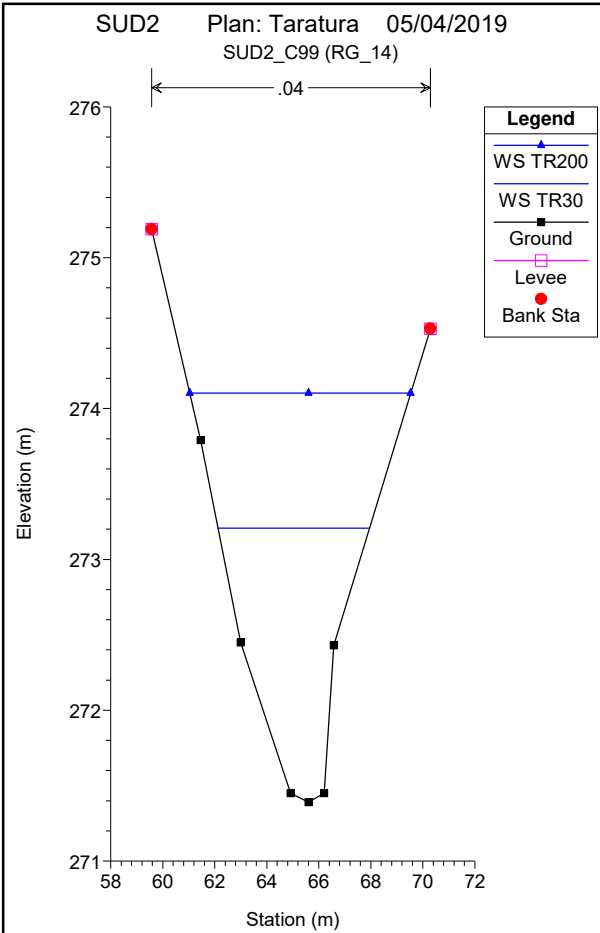

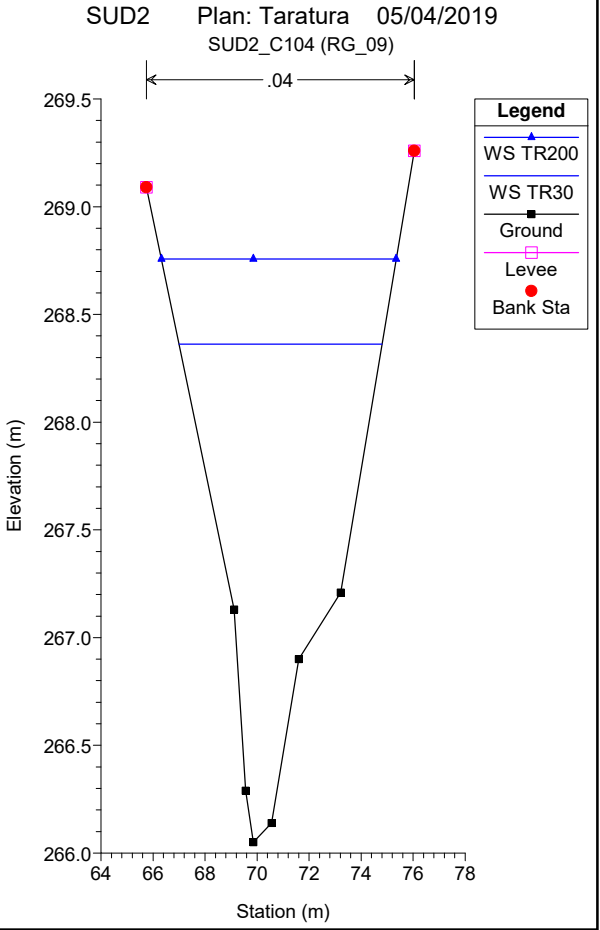
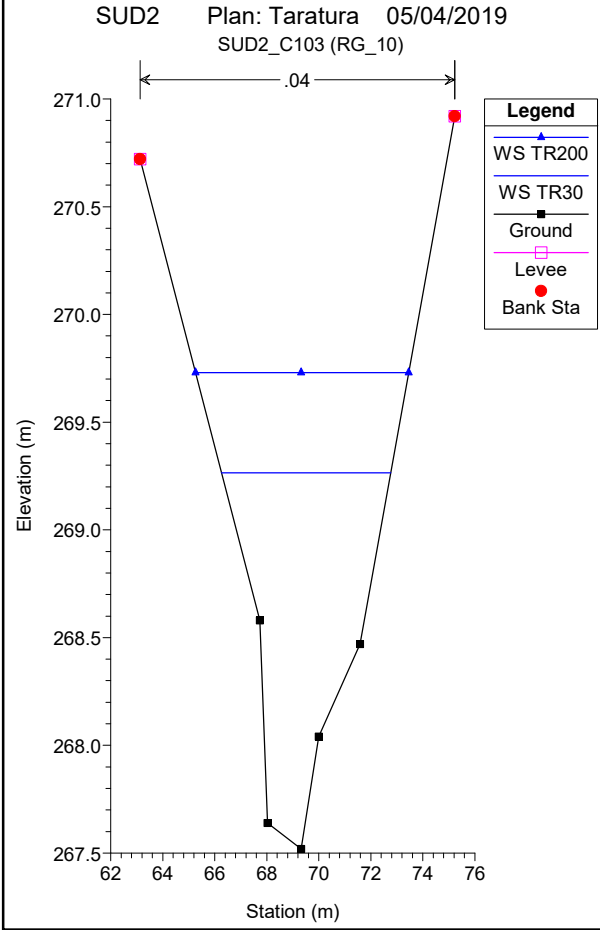
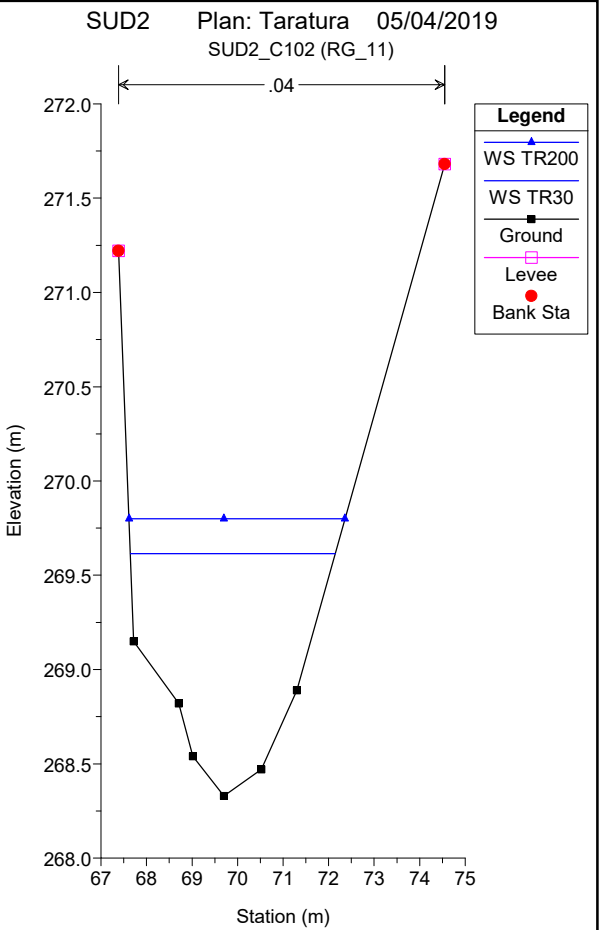
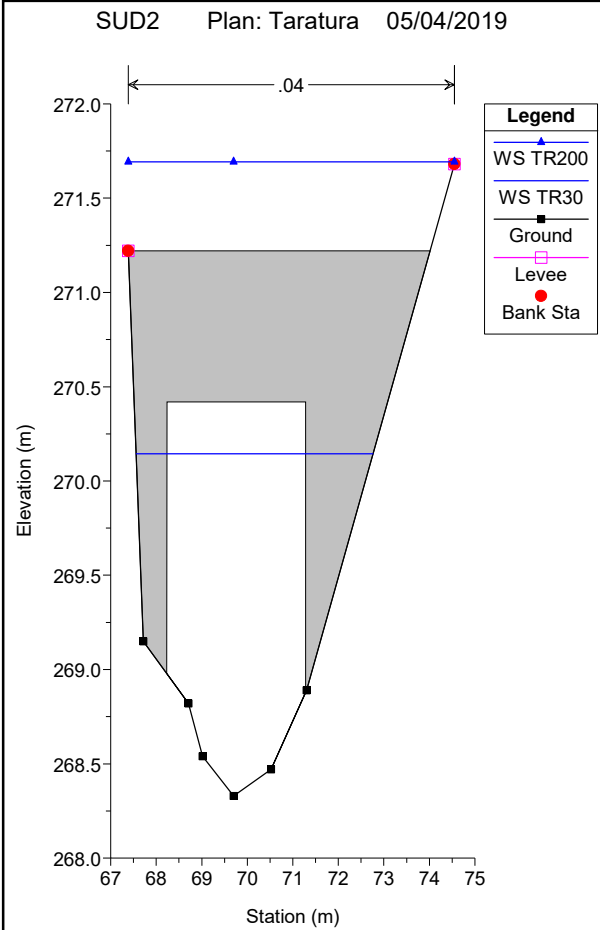

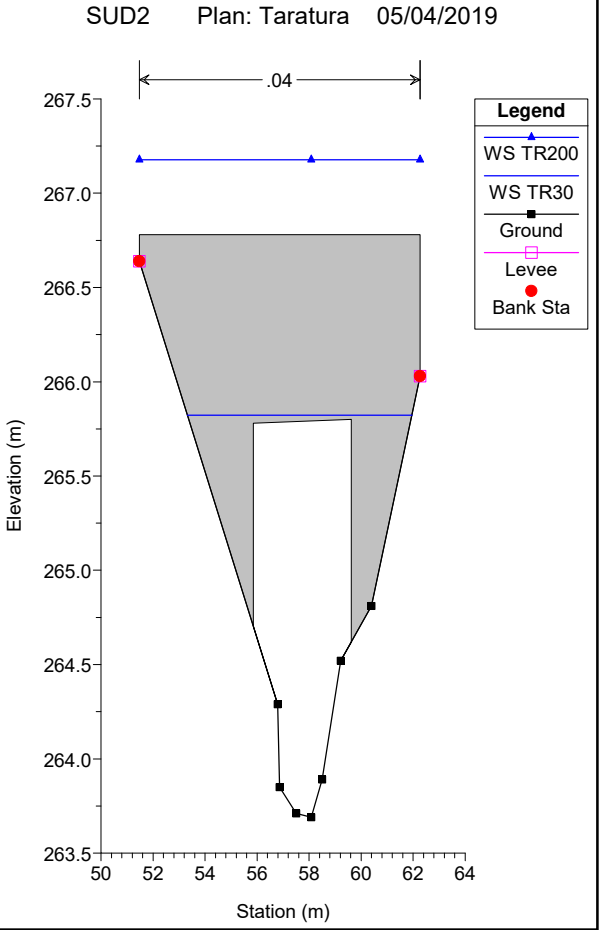
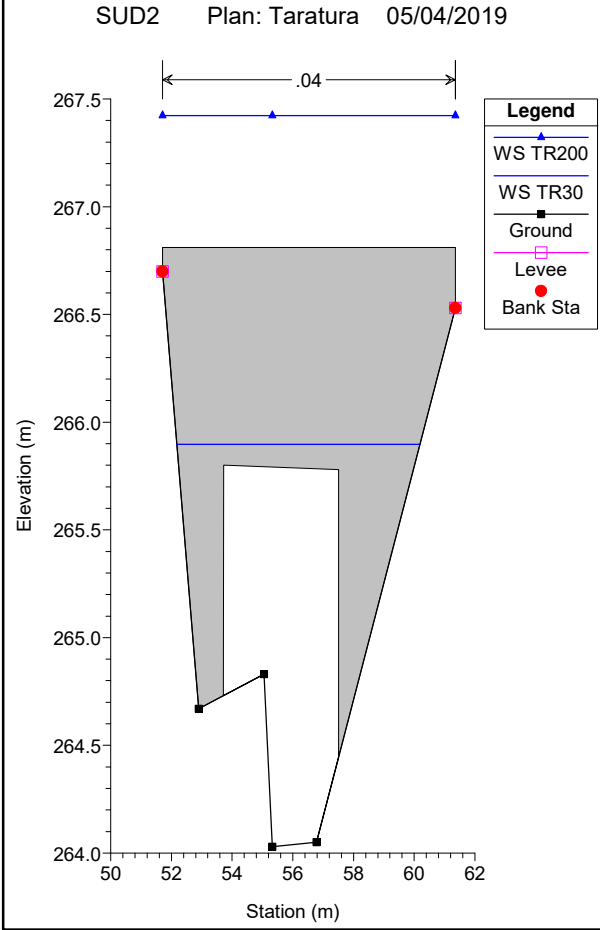
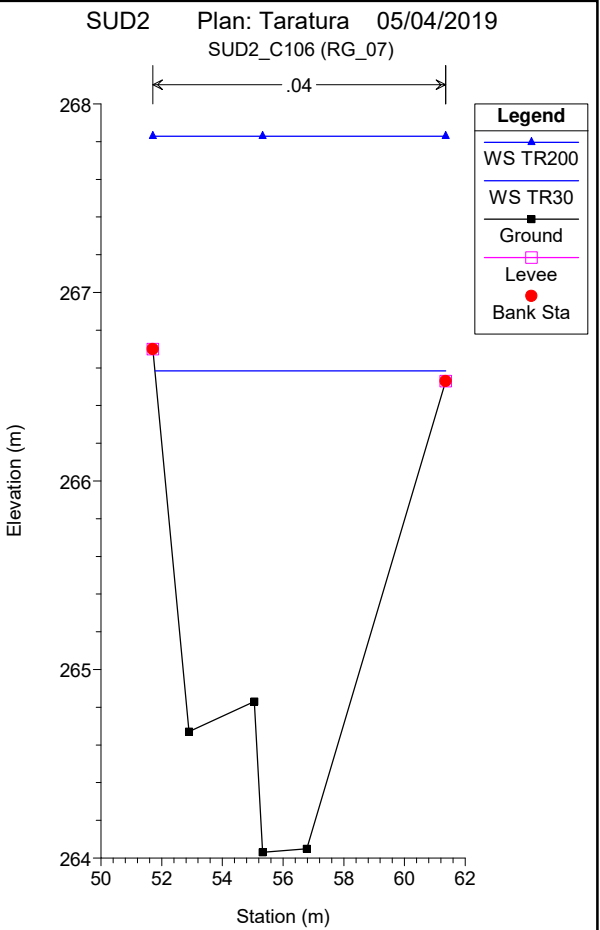
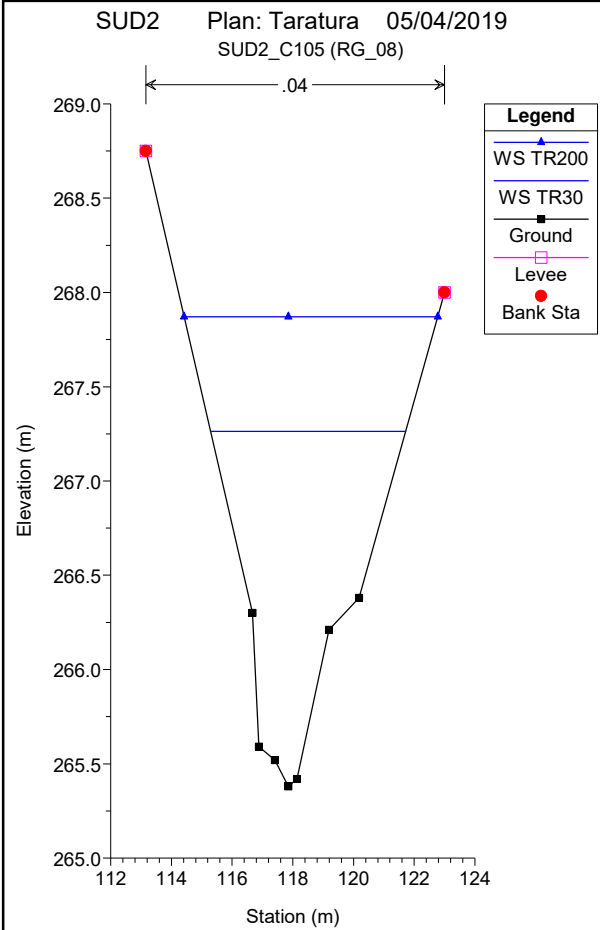

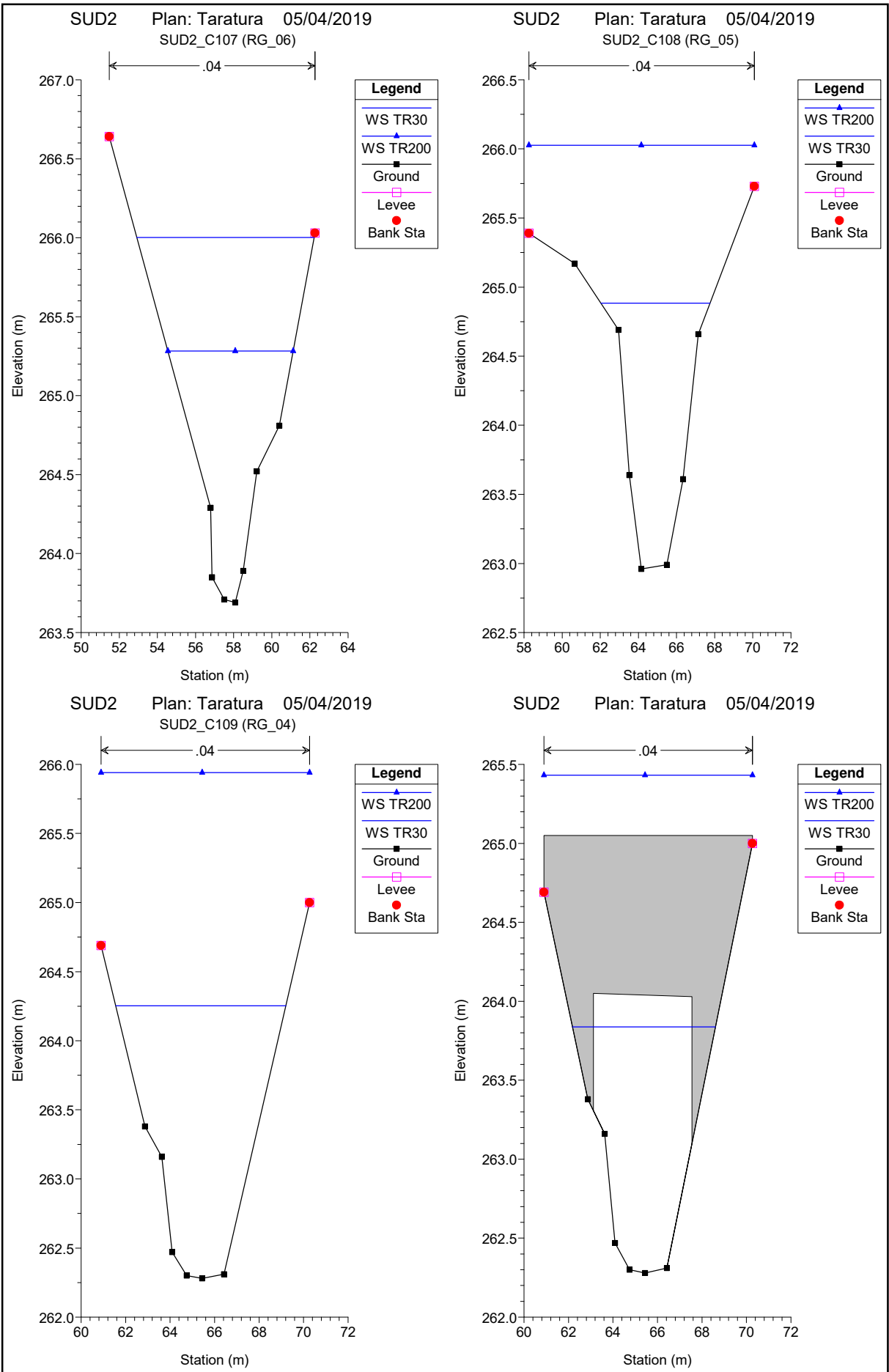

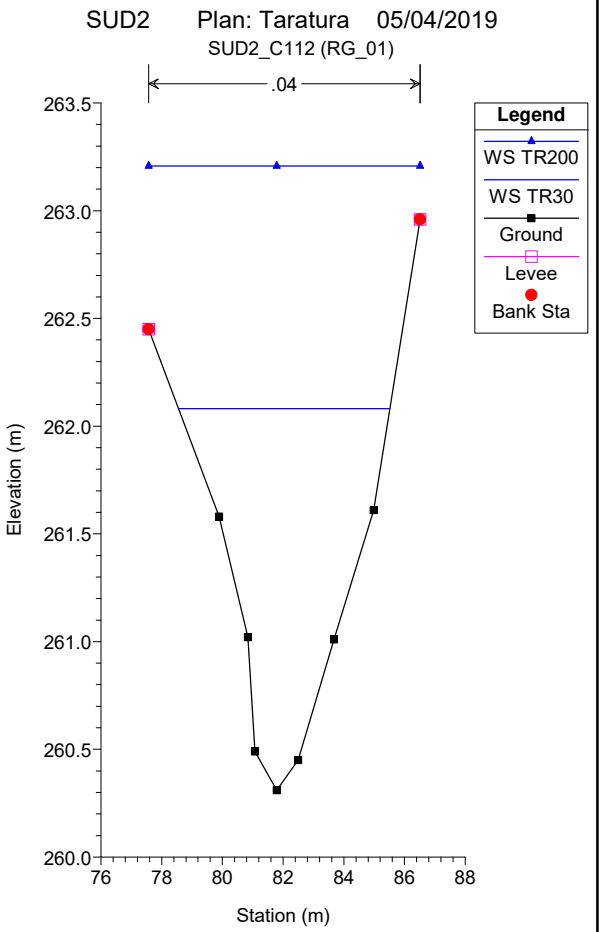
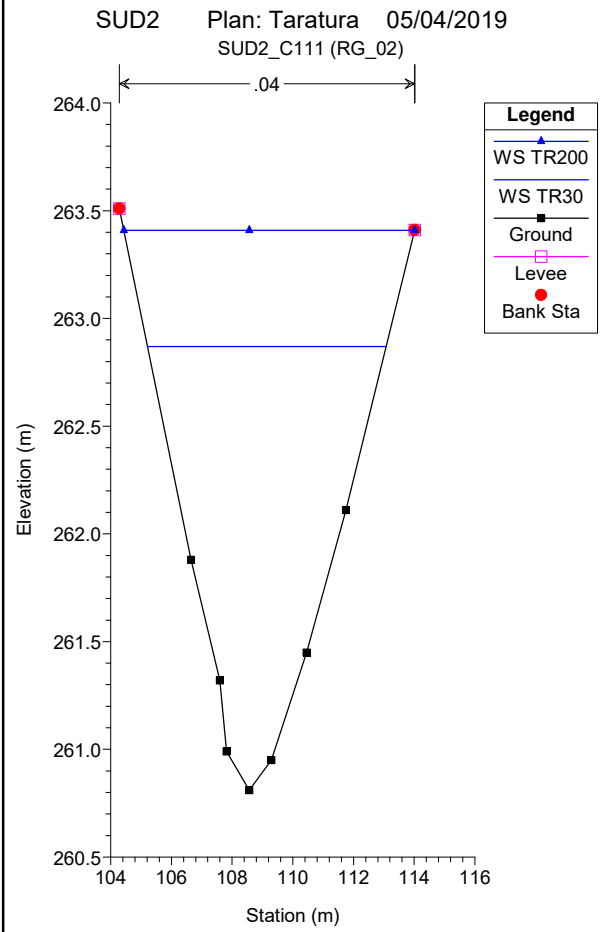
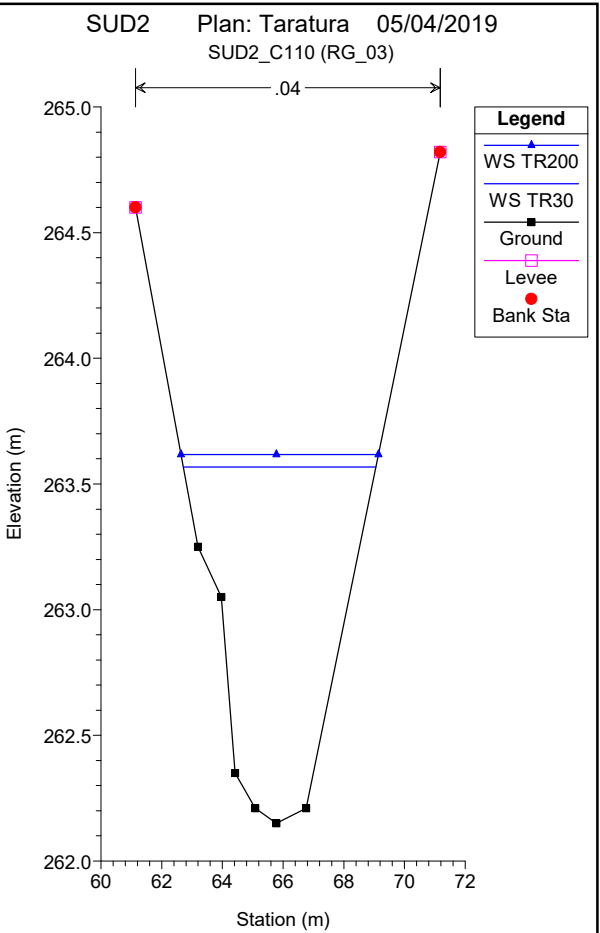
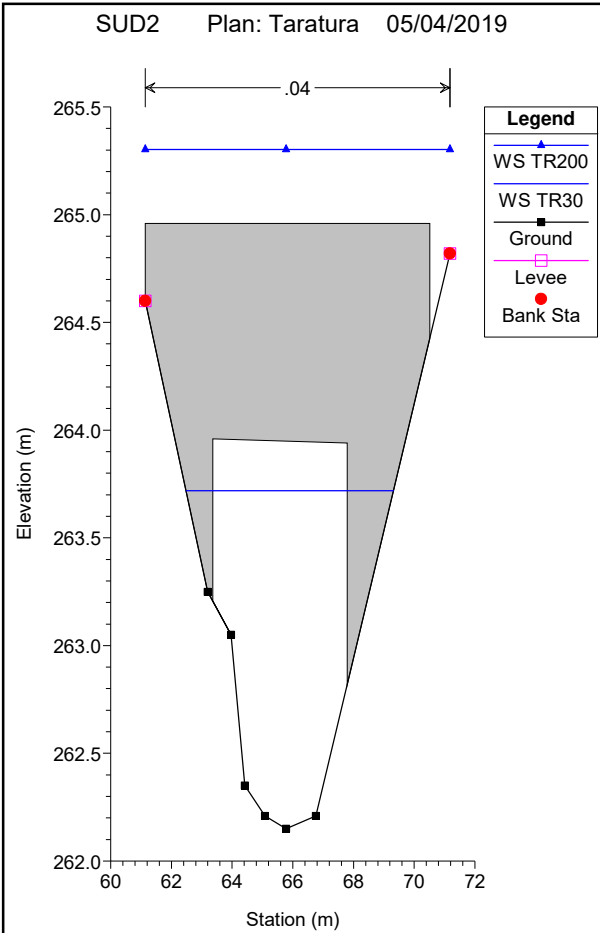

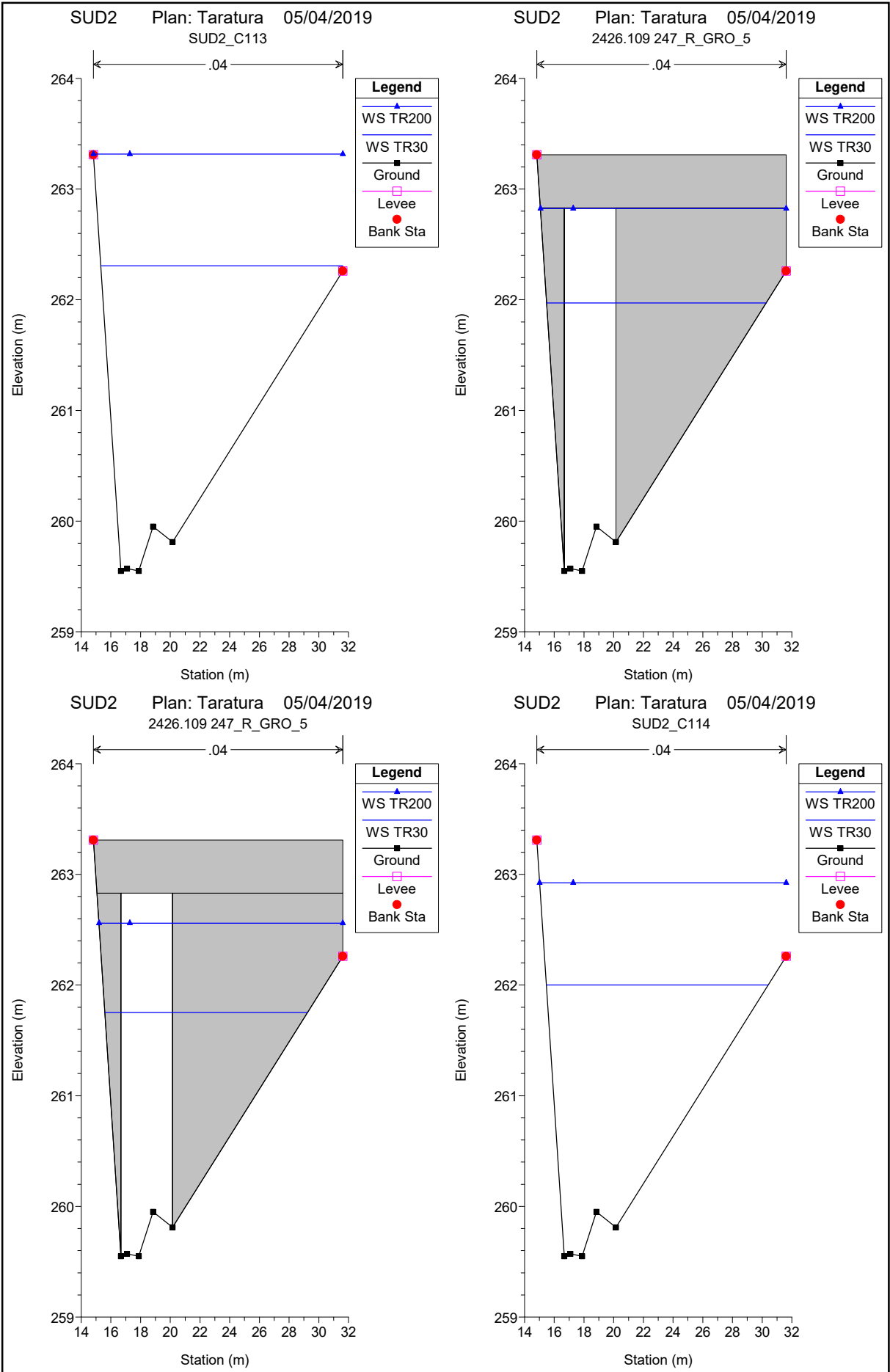

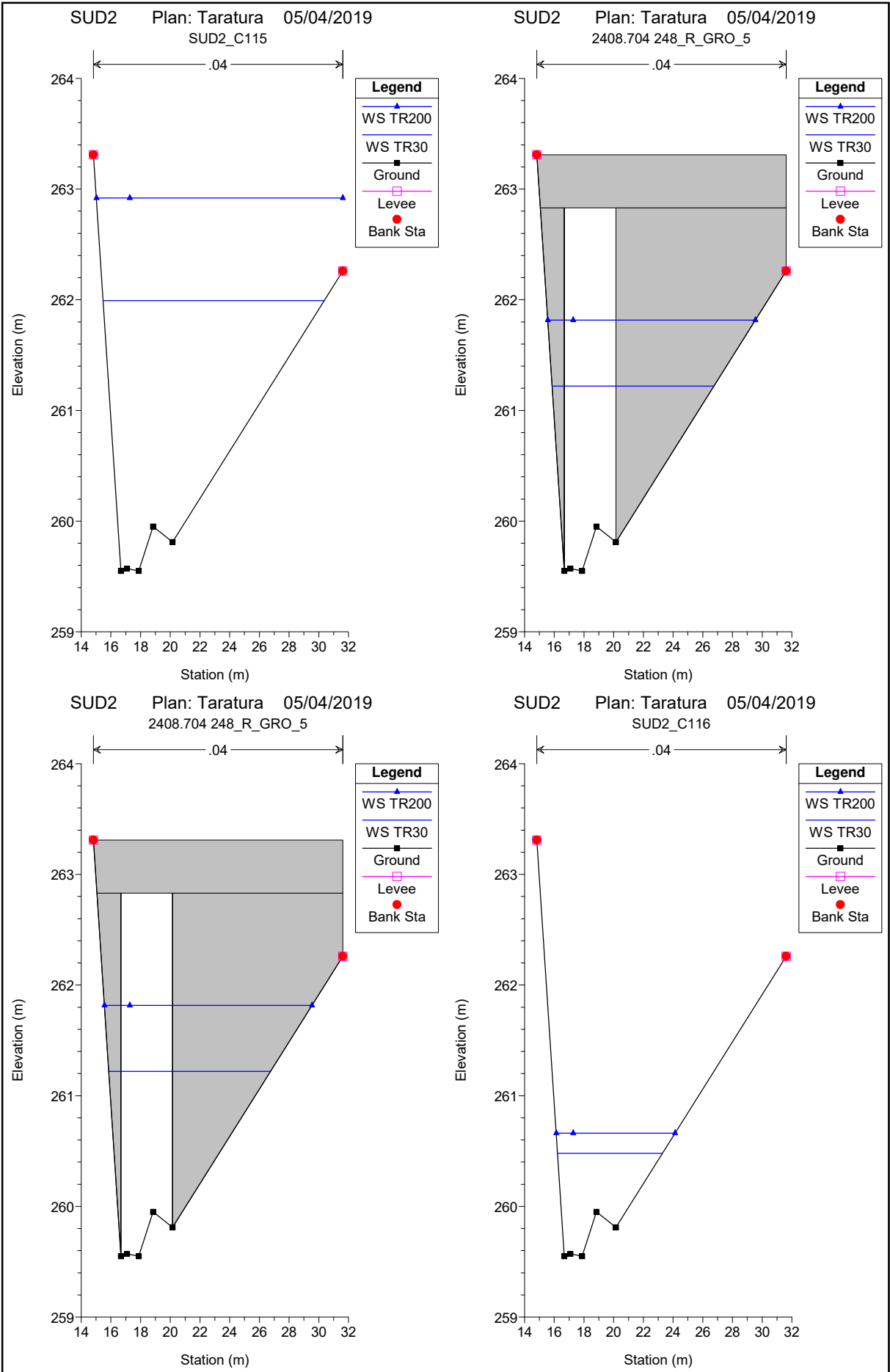

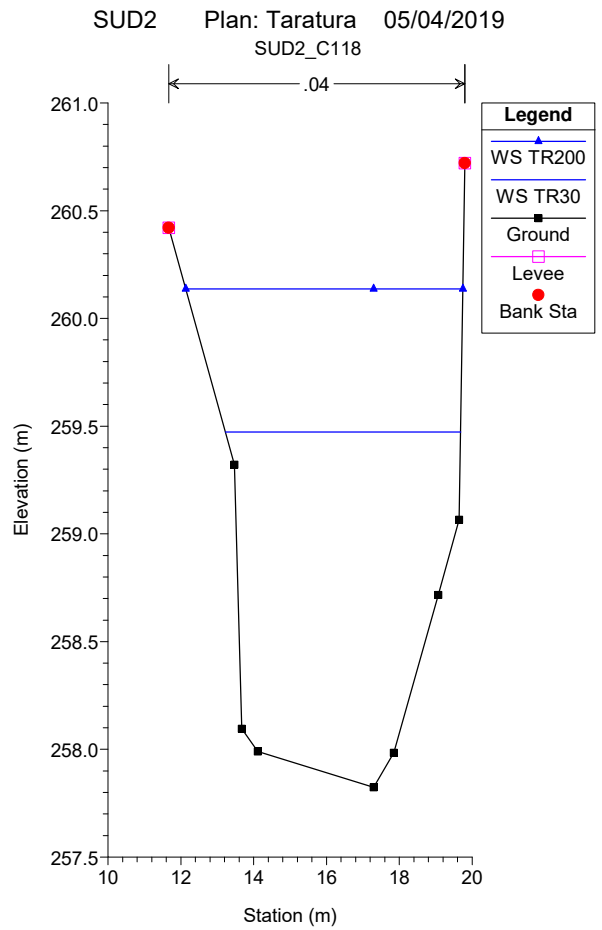
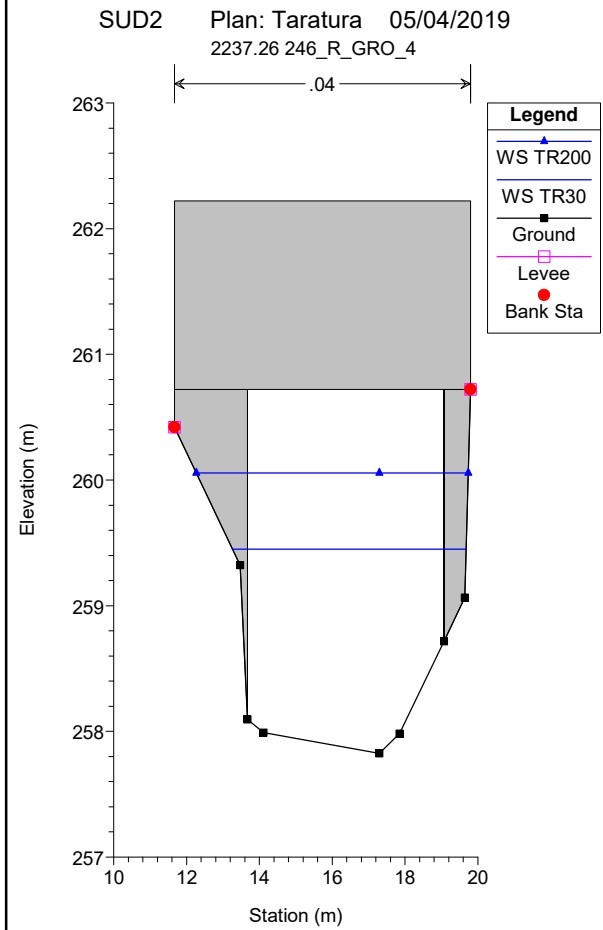
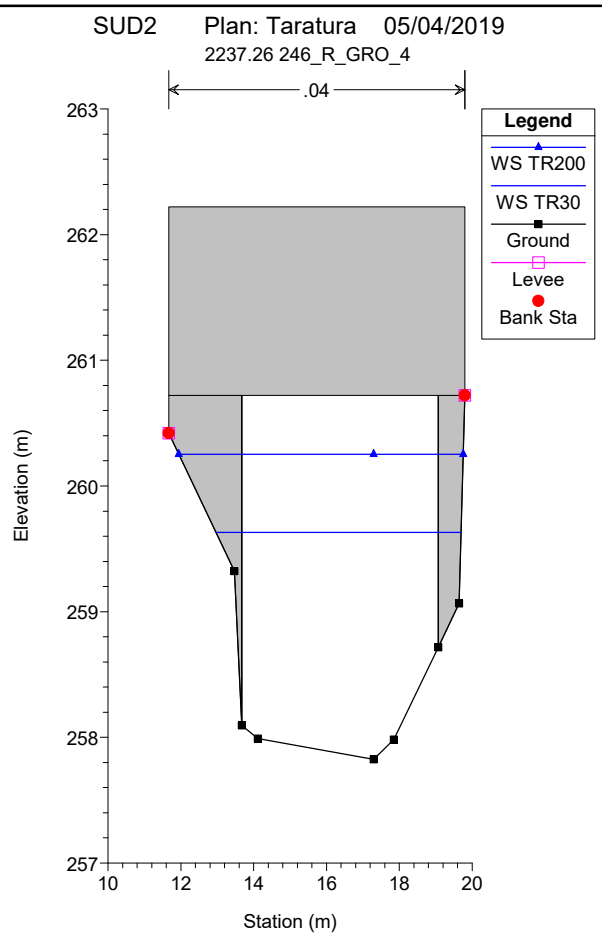
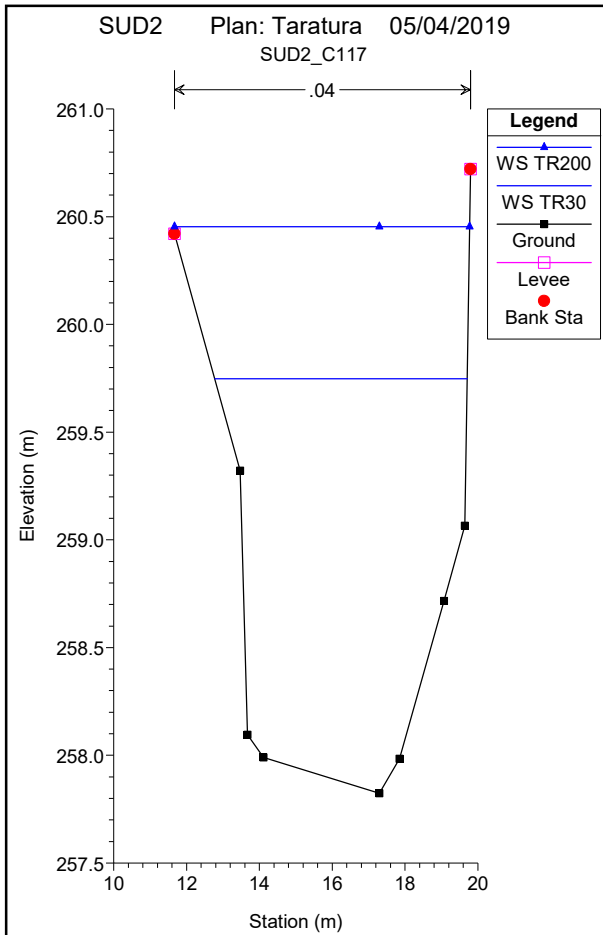

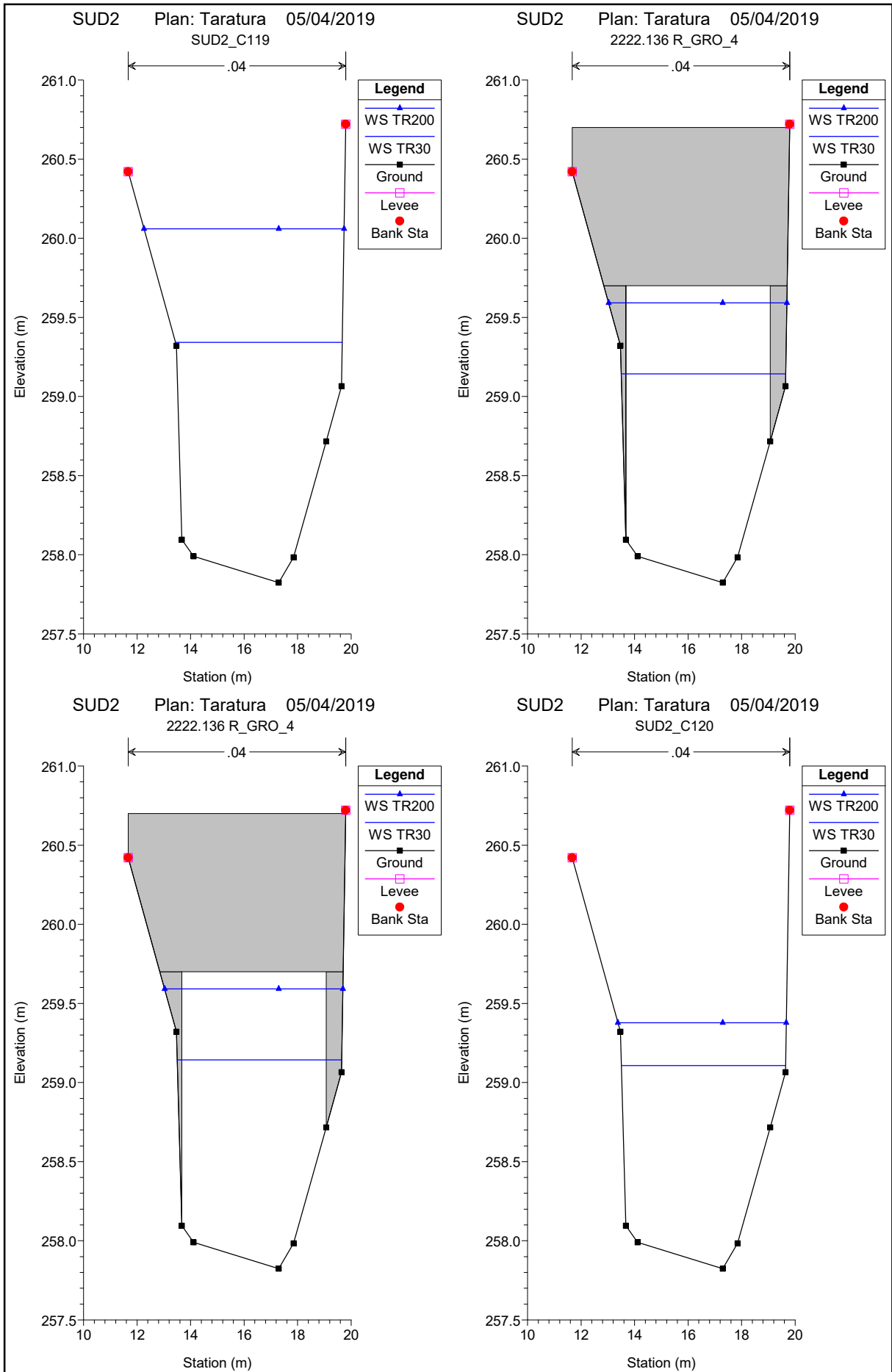

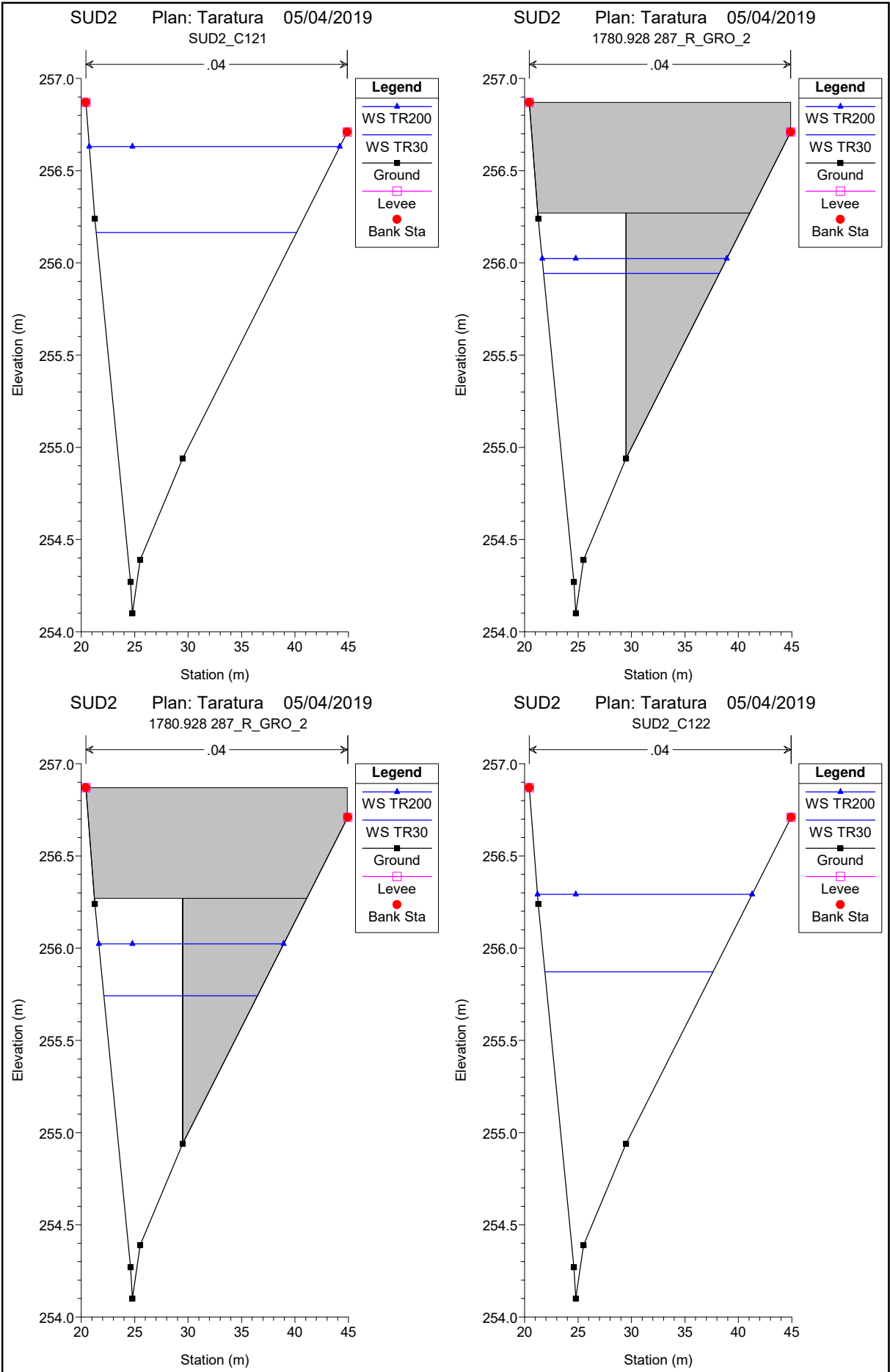

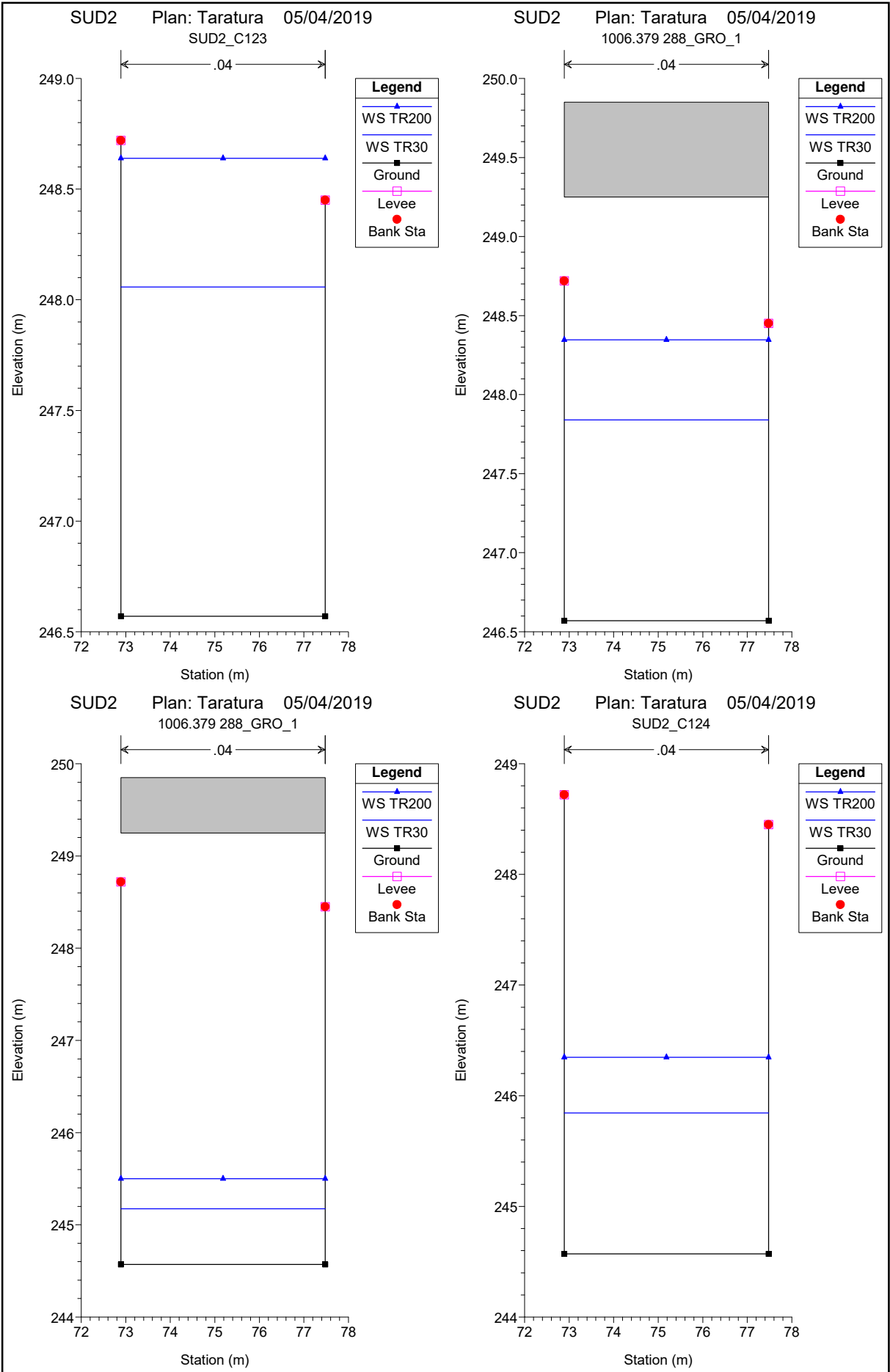

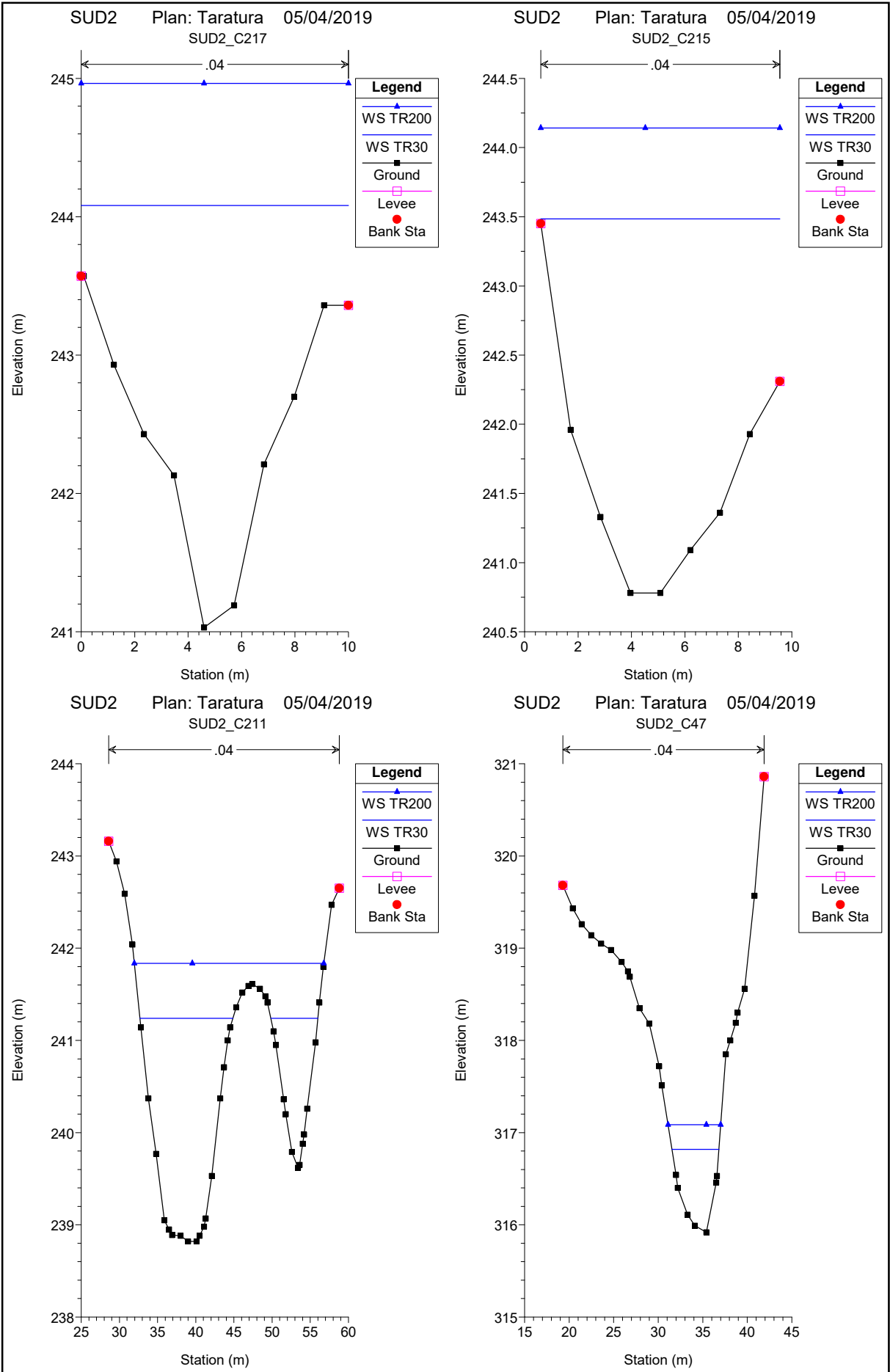

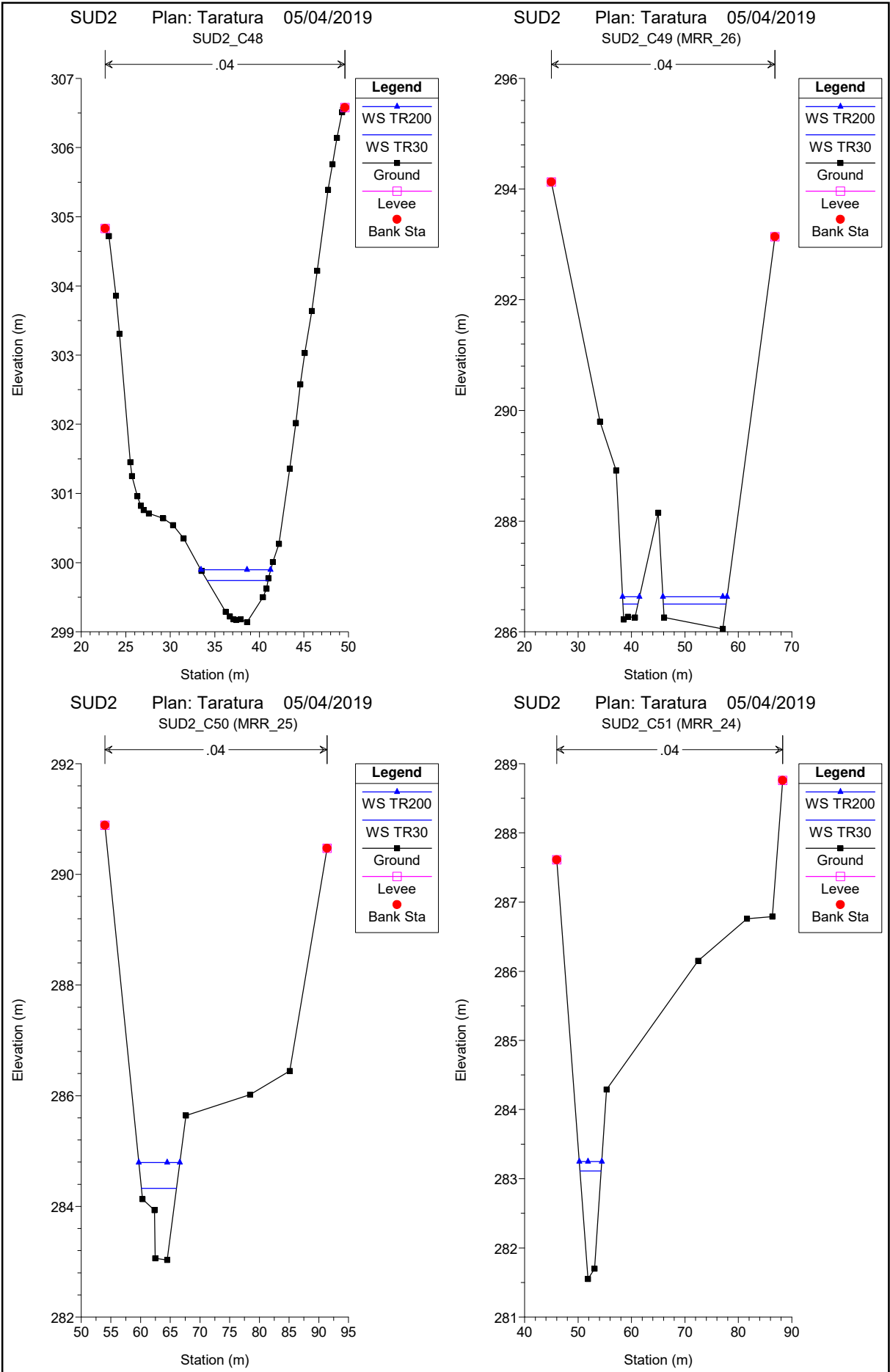

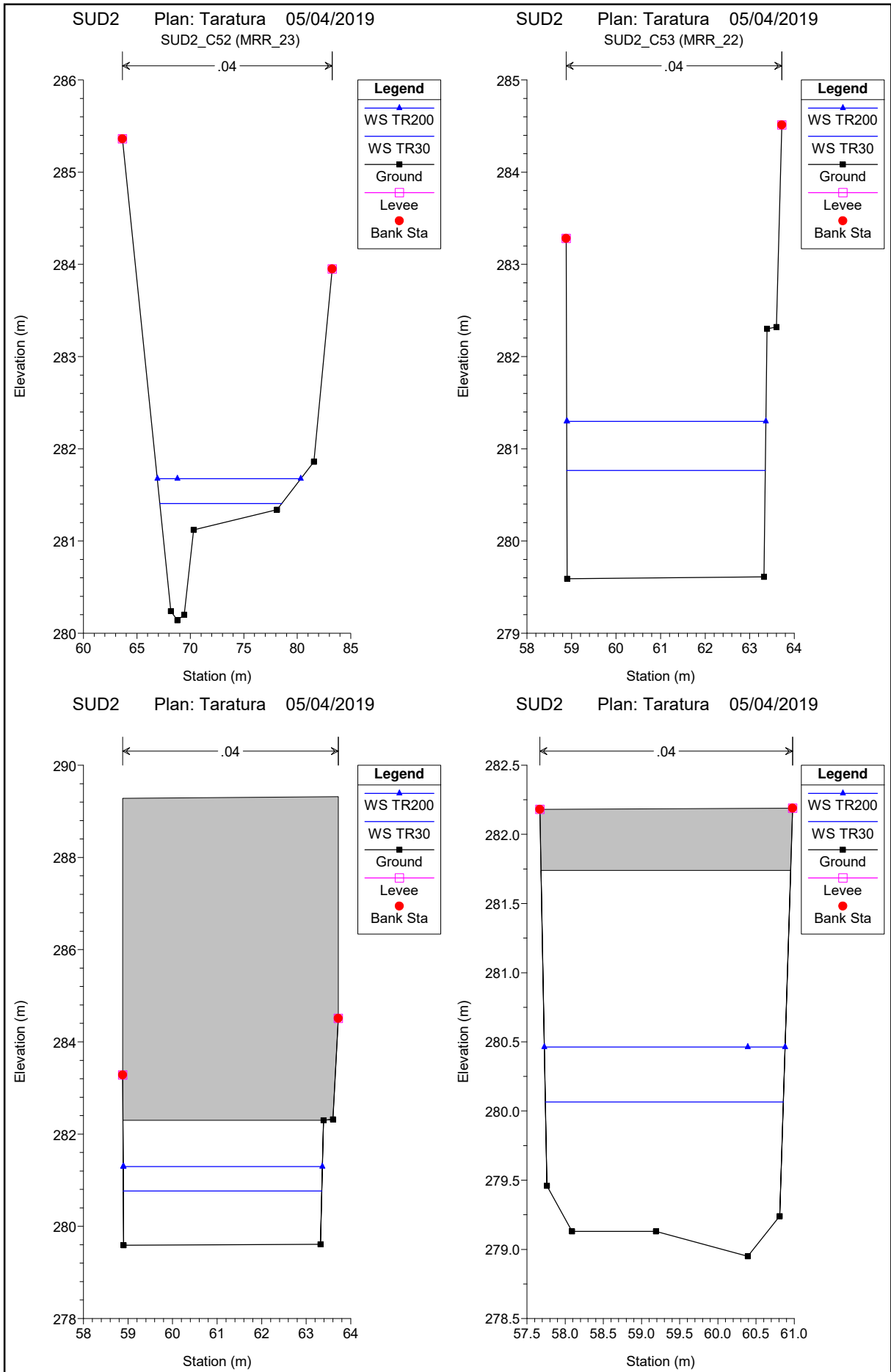

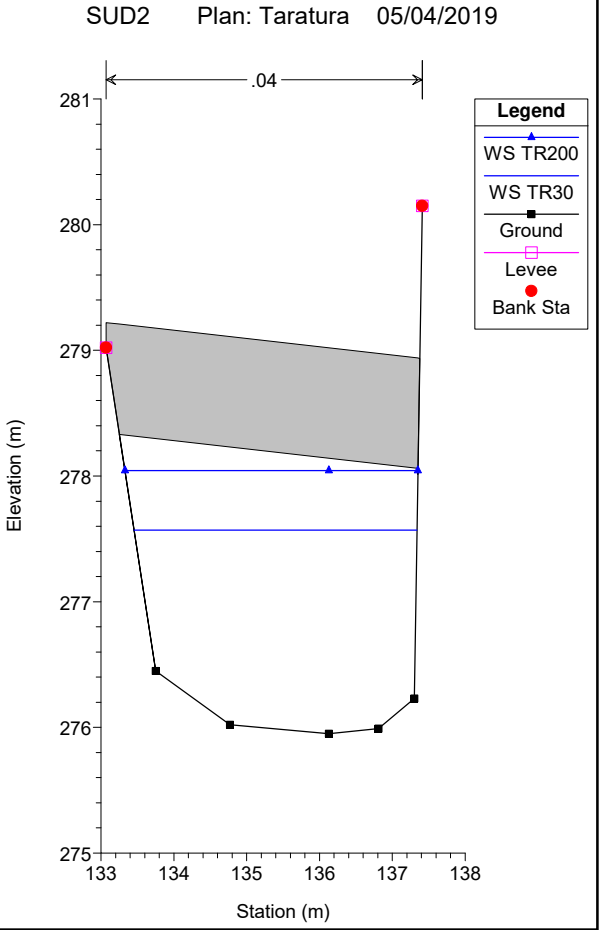
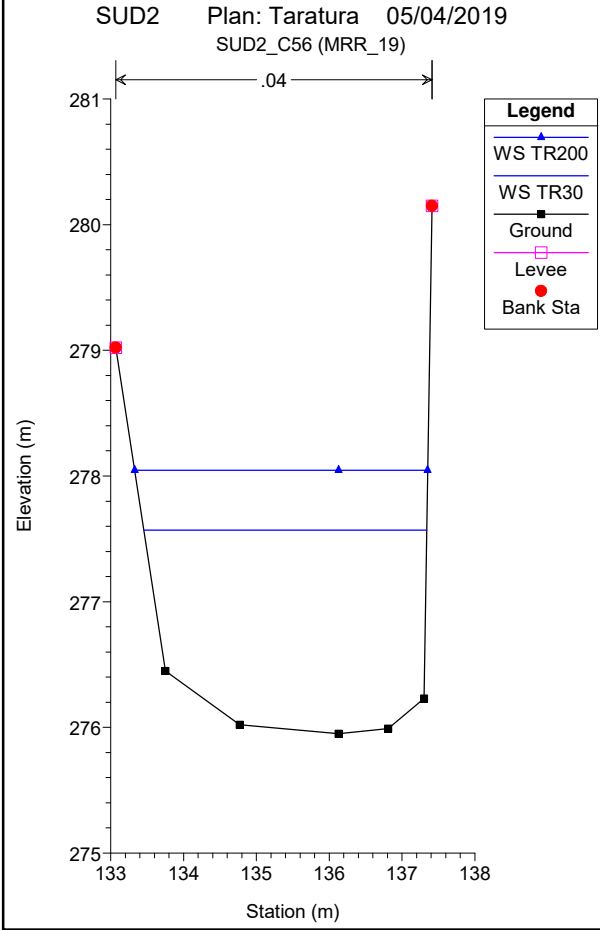
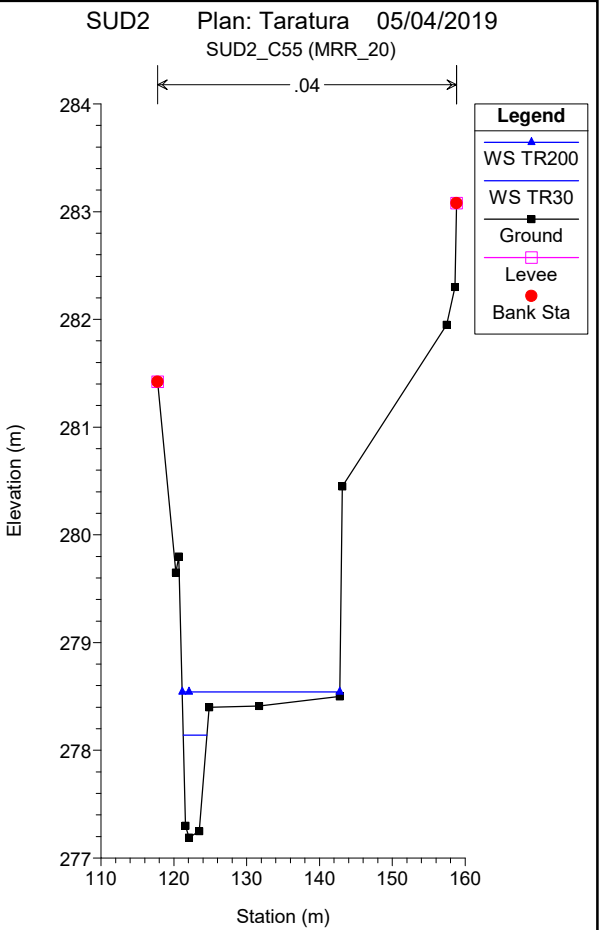
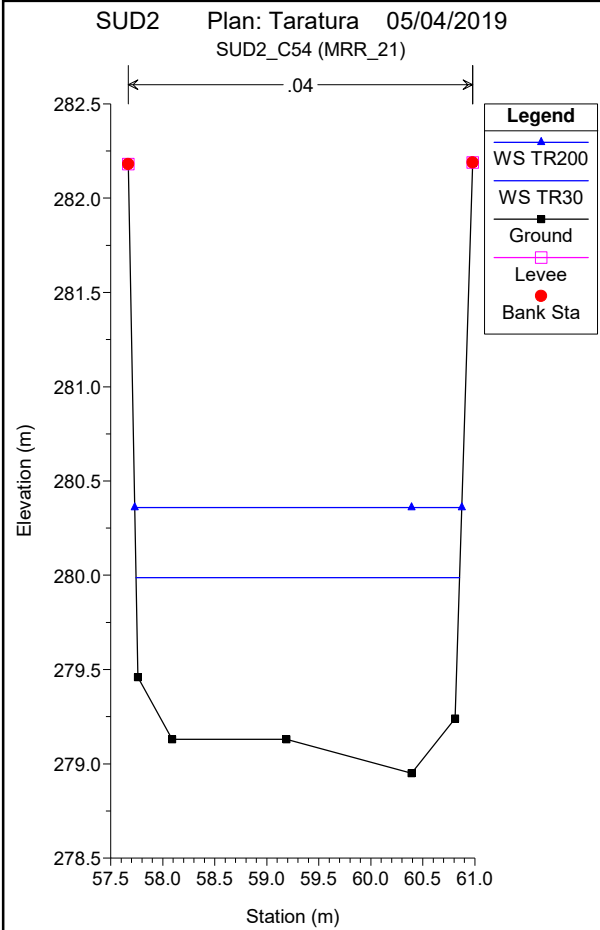

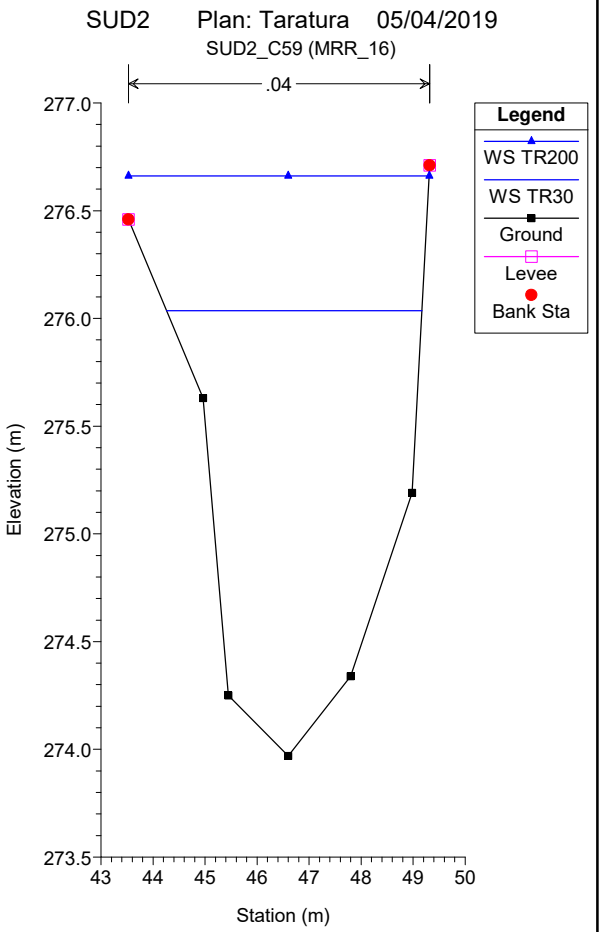
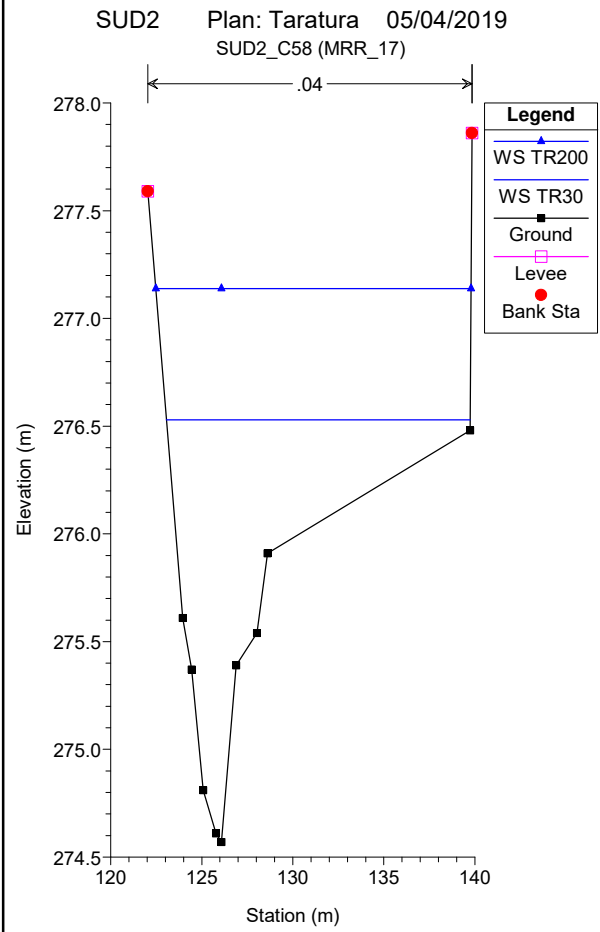
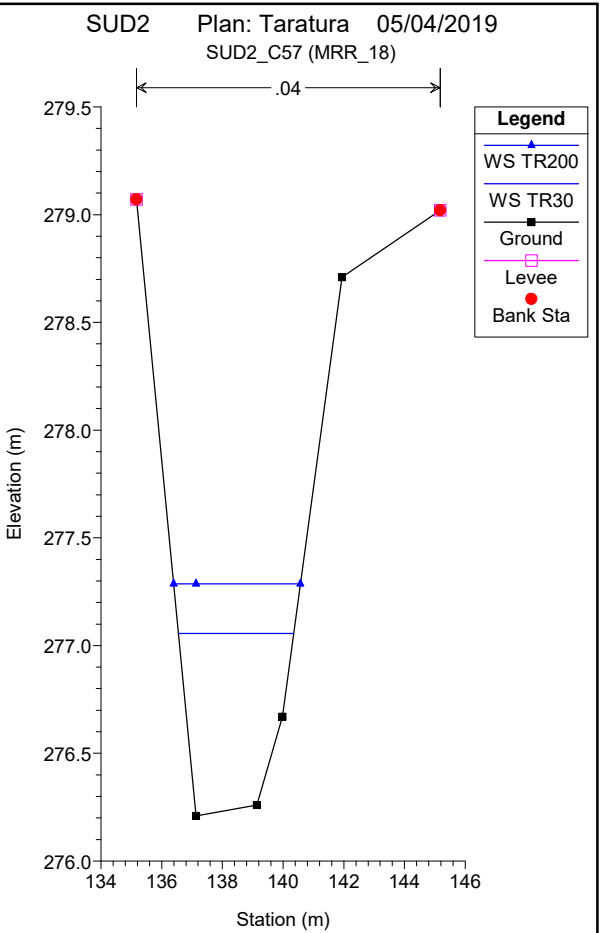
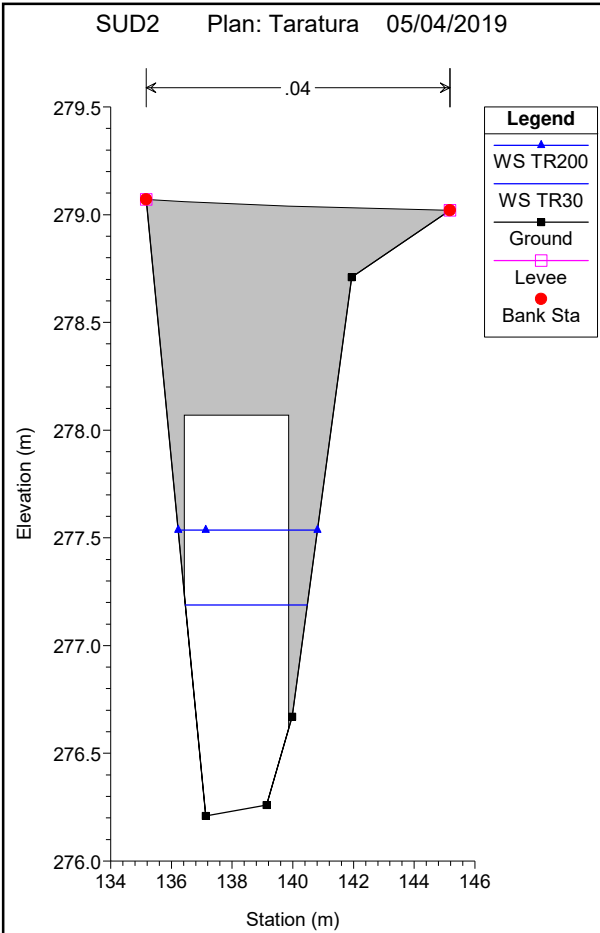

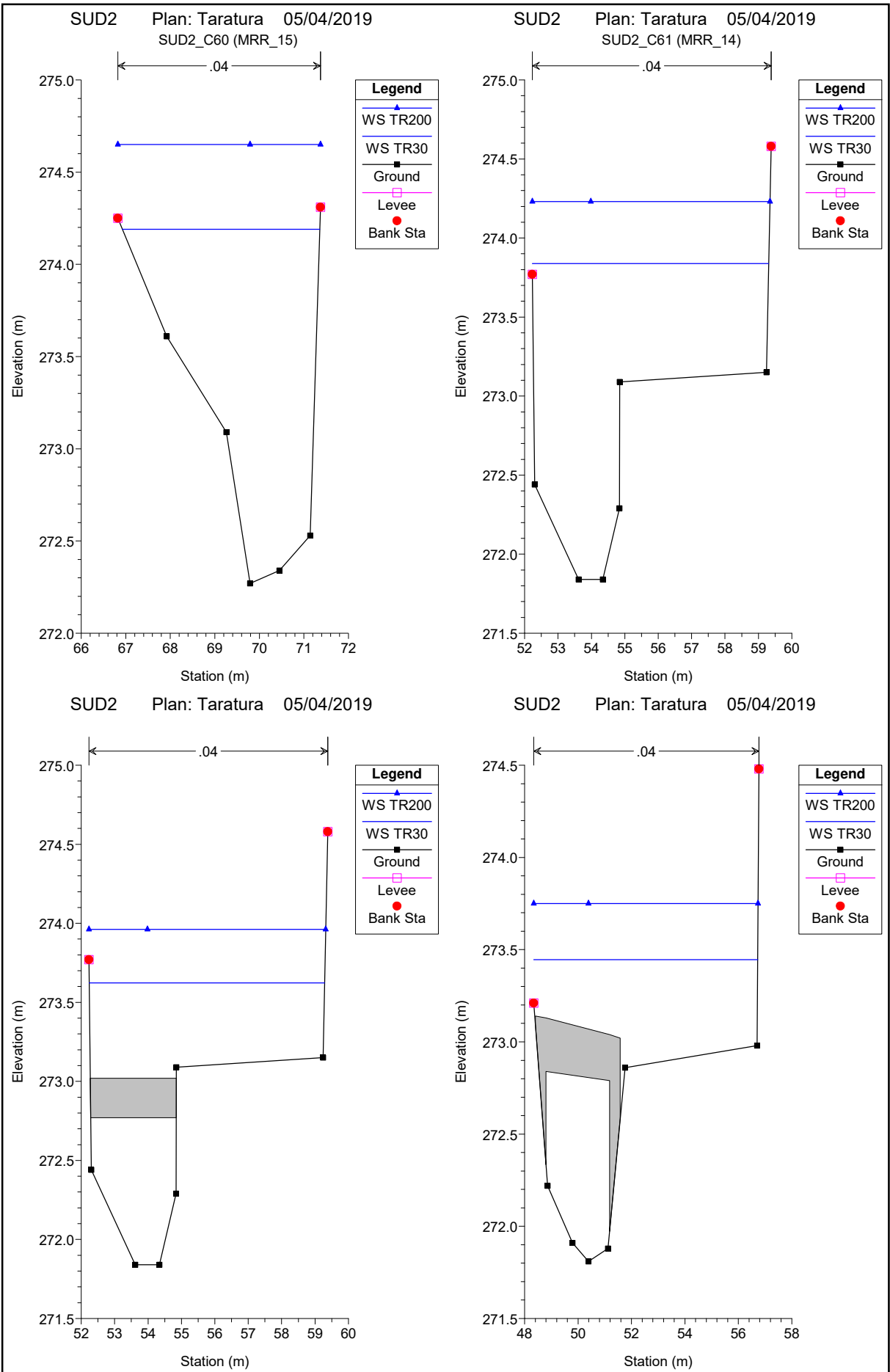

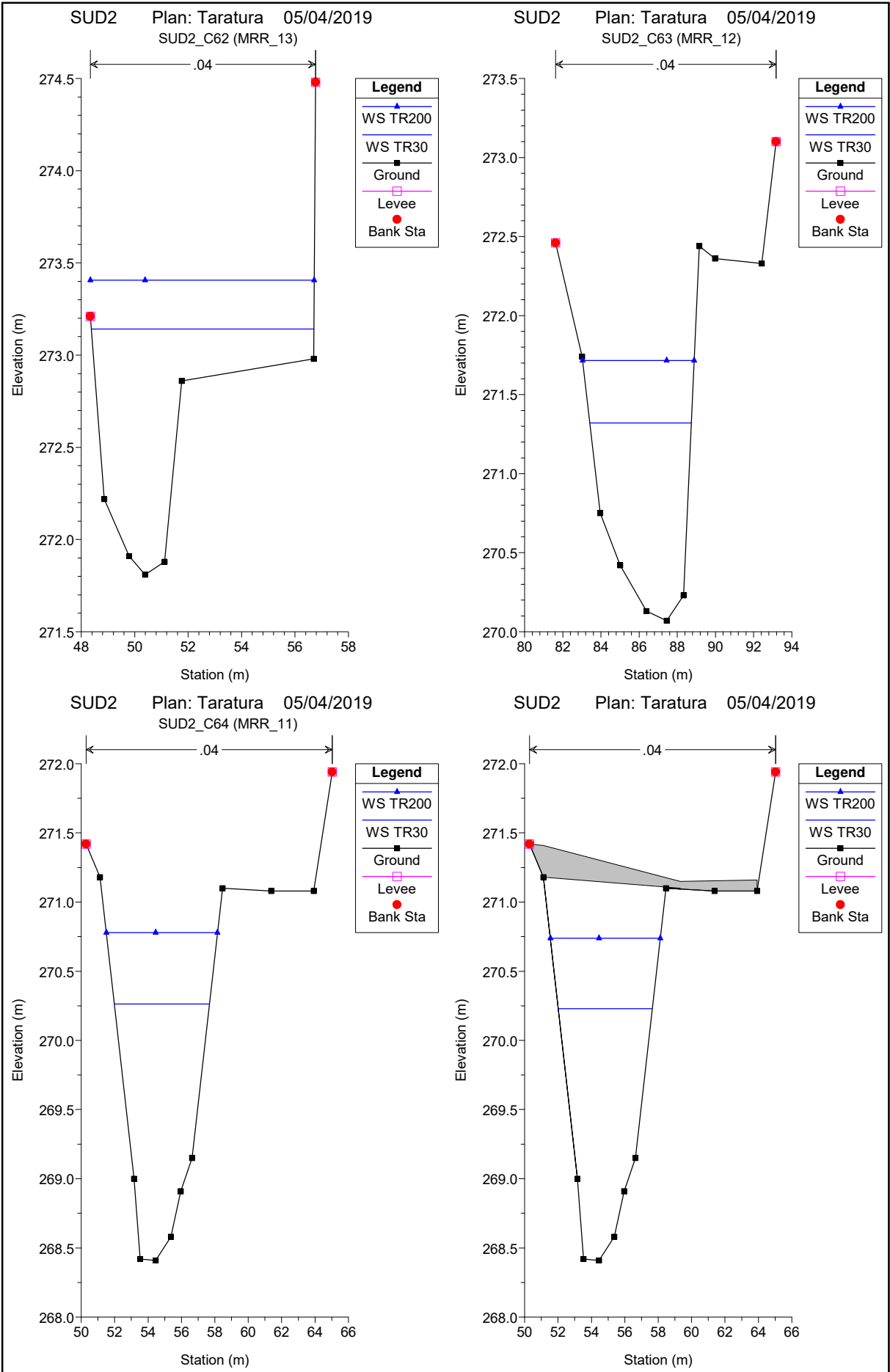

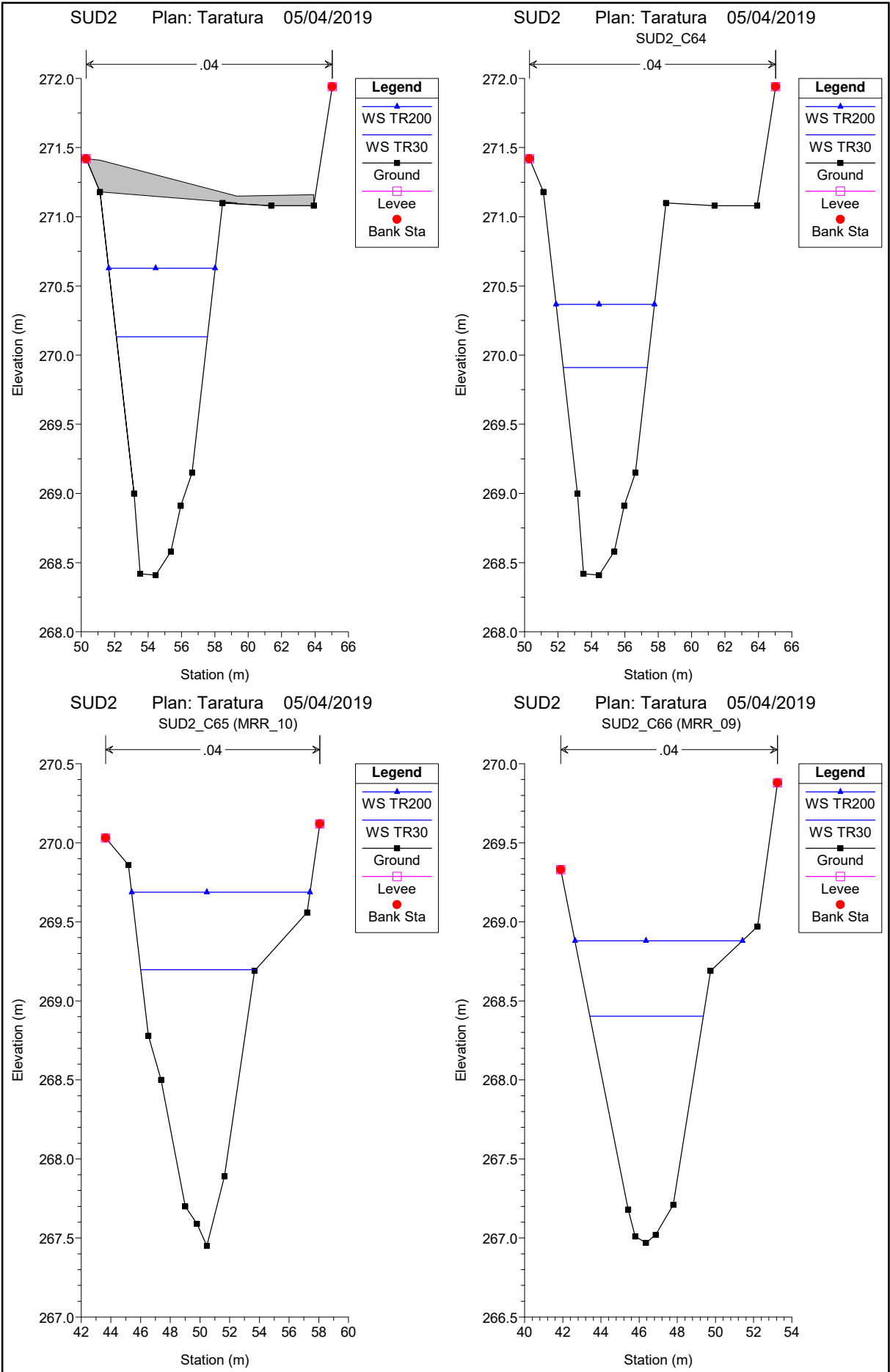

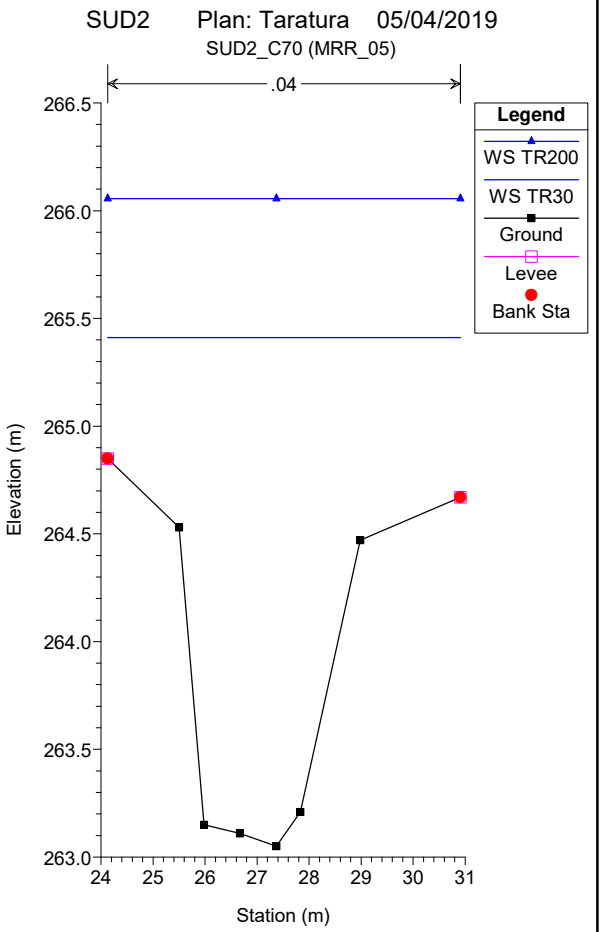
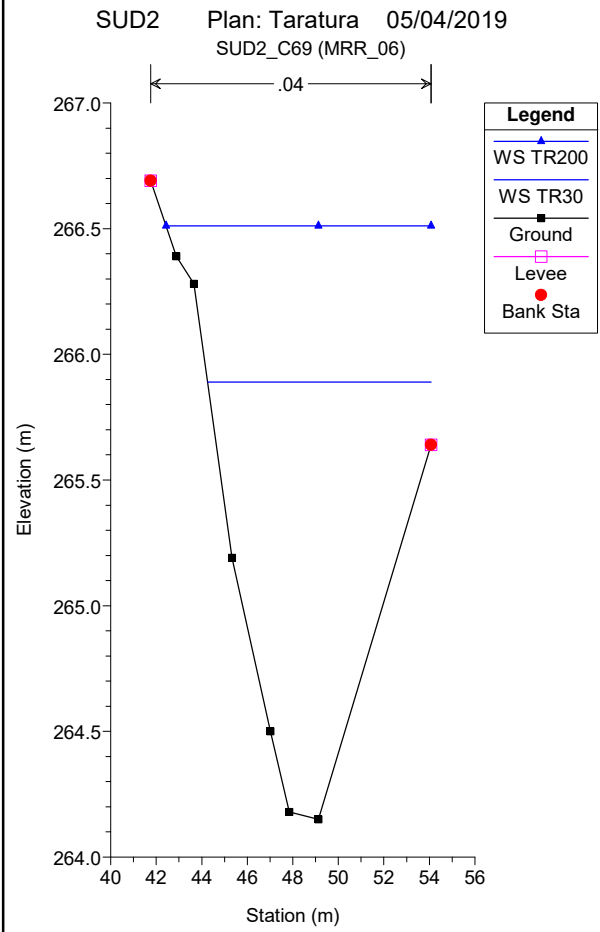
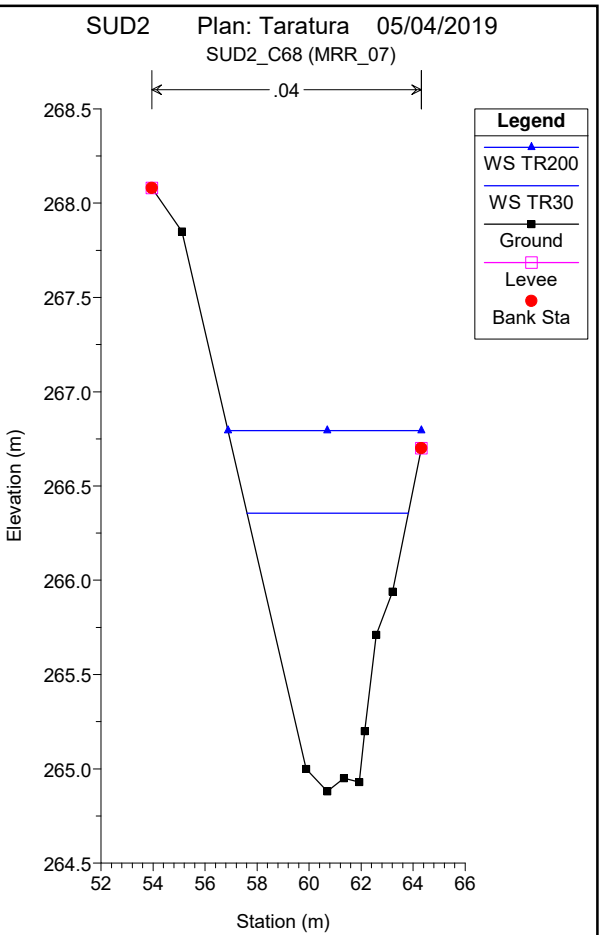
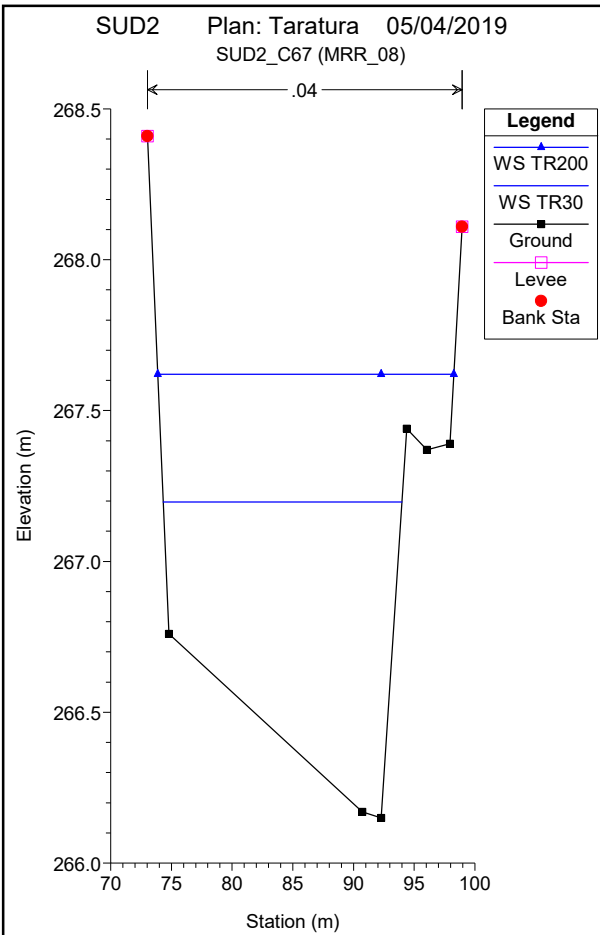

SUD2 Plan: Taratura 05/04/2019

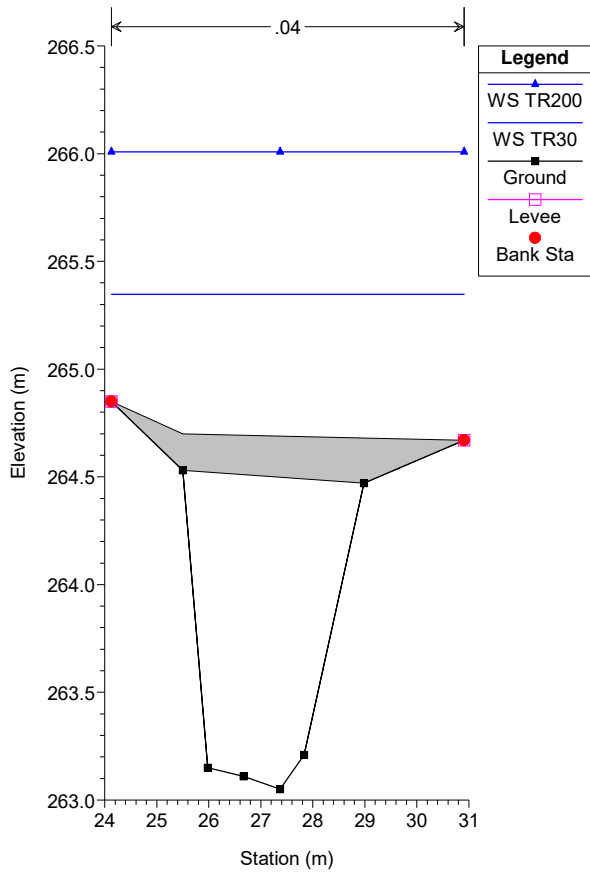

SUD2 Plan: Taratura 05/04/2019

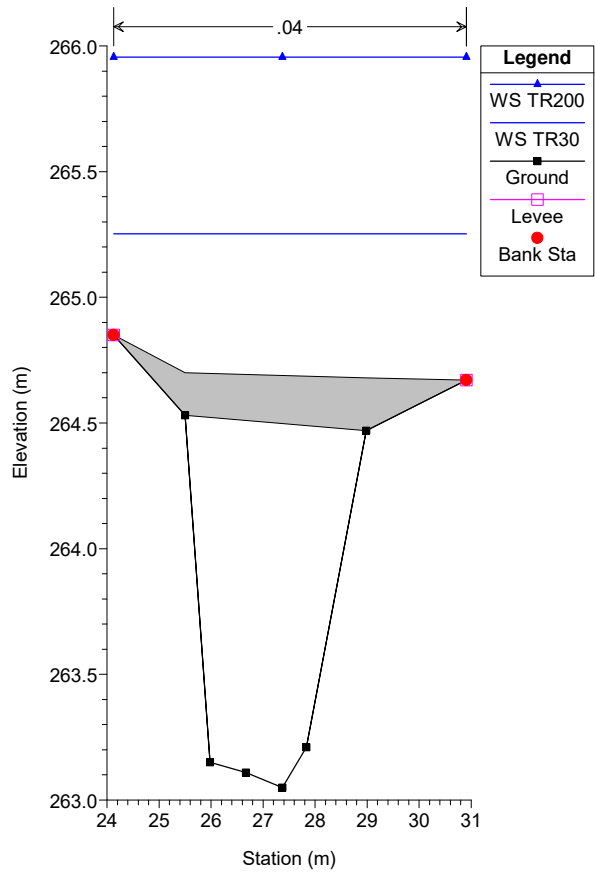

SUD2 Plan: Taratura 05/04/2019
SUD2_C70

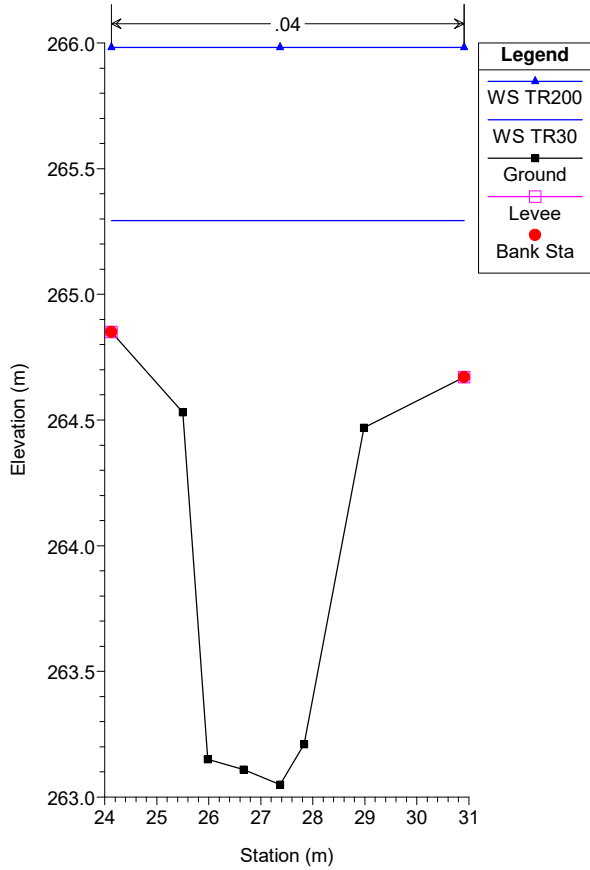

SUD2 Plan: Taratura 05/04/2019
SUD2_C71 (MRR_04)

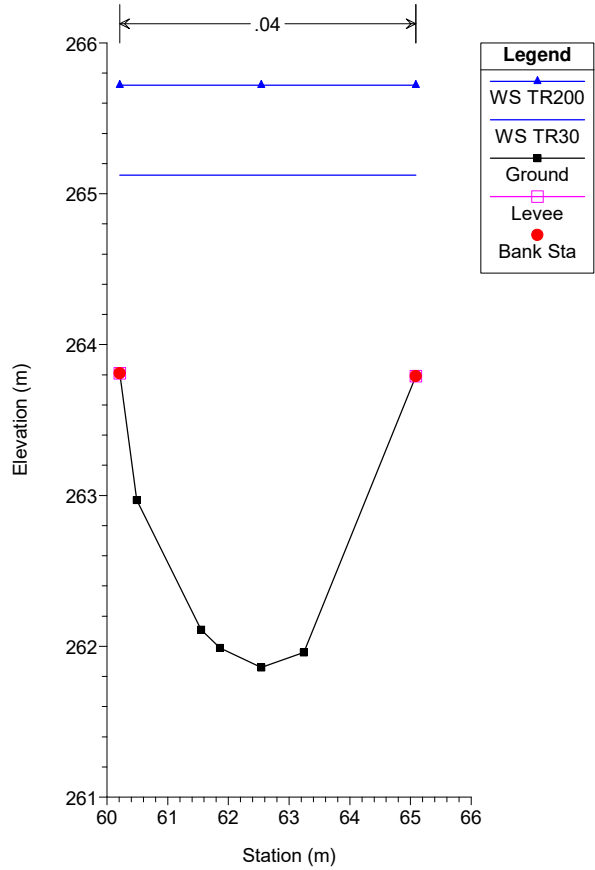

SUD2 Plan: Taratura 05/04/2019

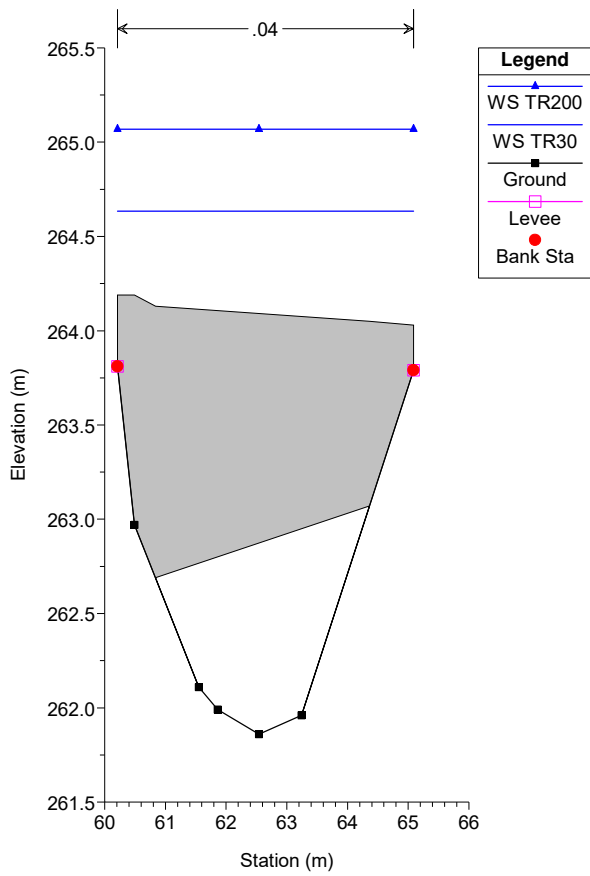

SUD2 Plan: Taratura 05/04/2019

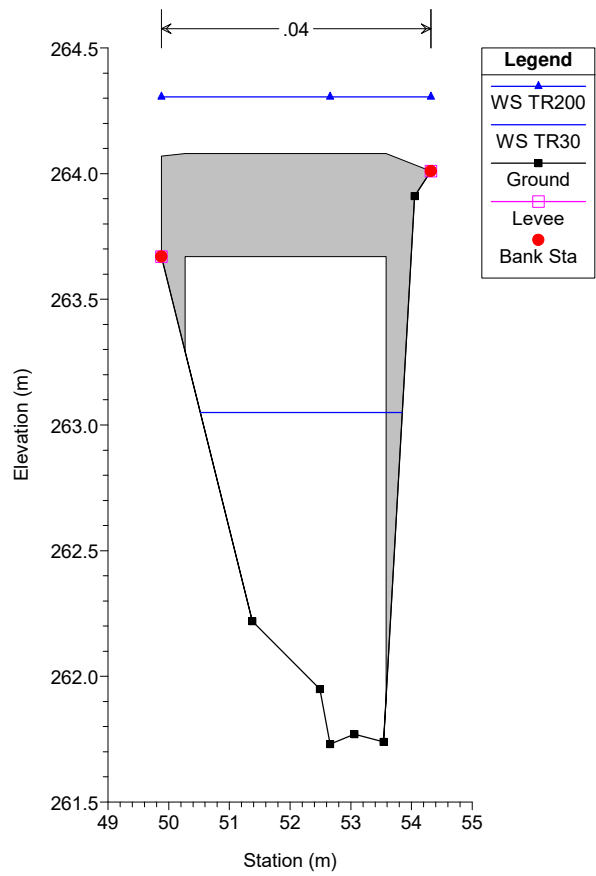

SUD2 Plan: Taratura 05/04/2019
SUD2_C72 (MRR_03)

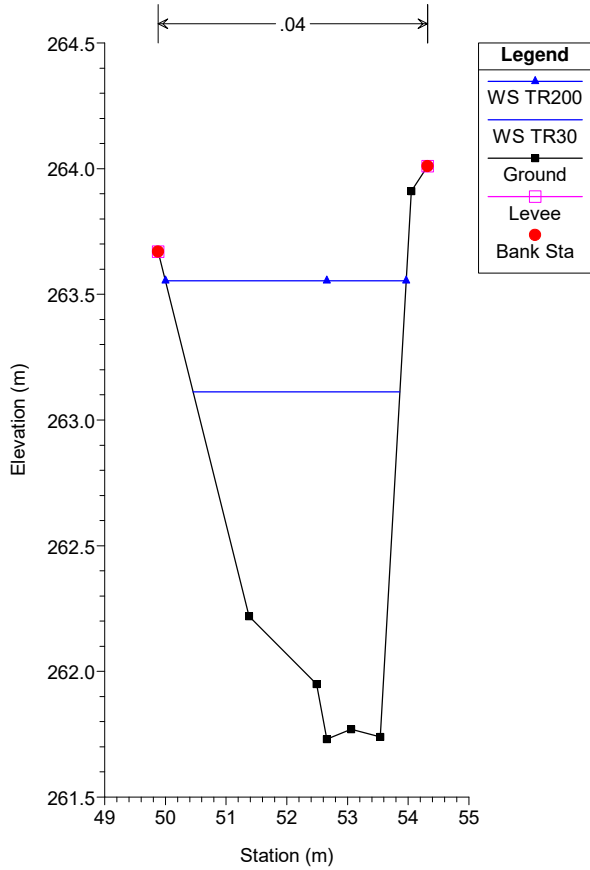

SUD2 Plan: Taratura 05/04/2019
SUD2_C73 (MRR_02)

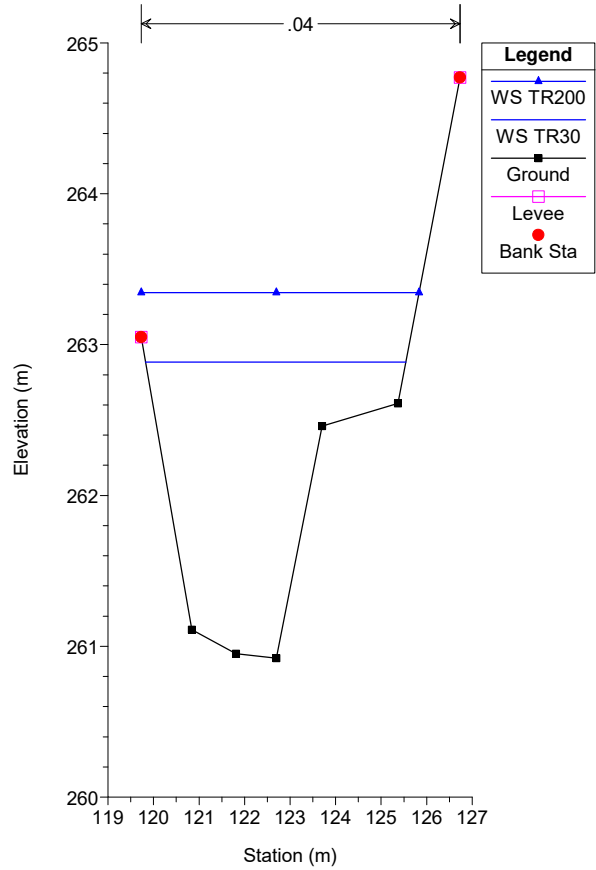

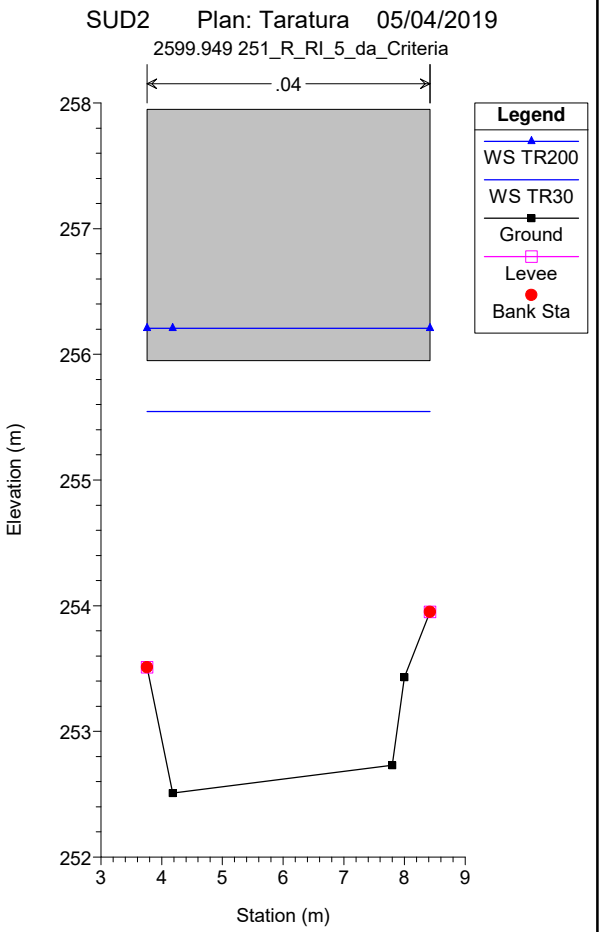
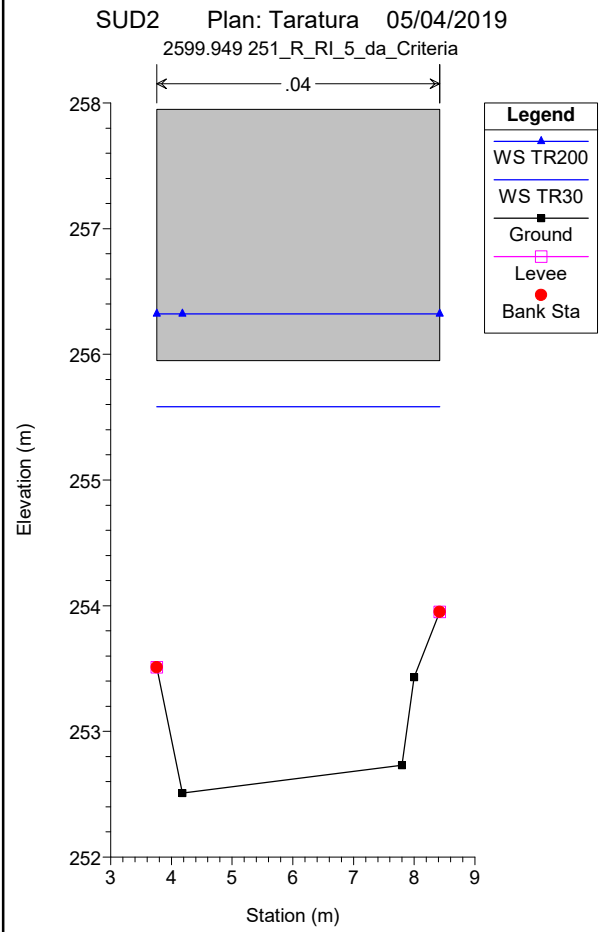
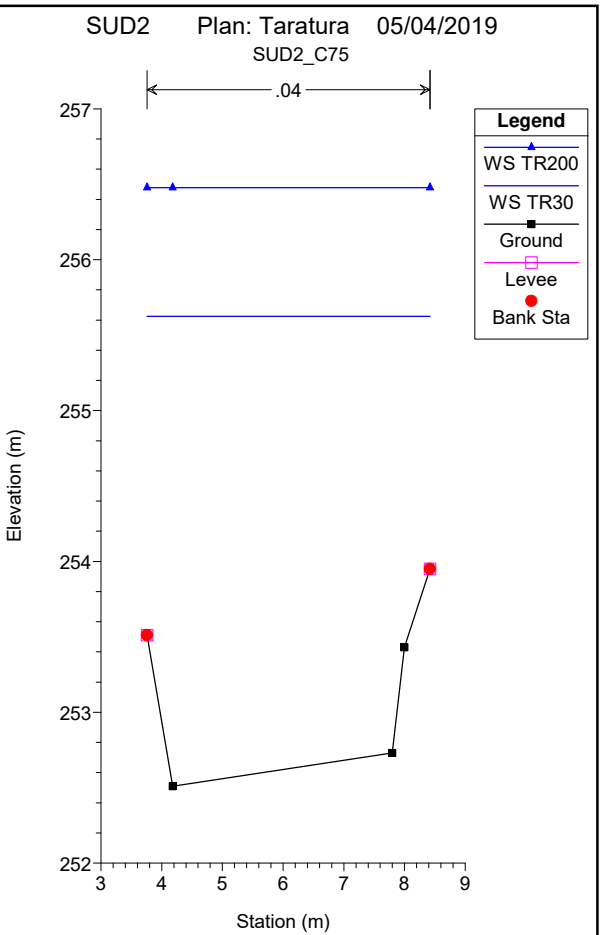
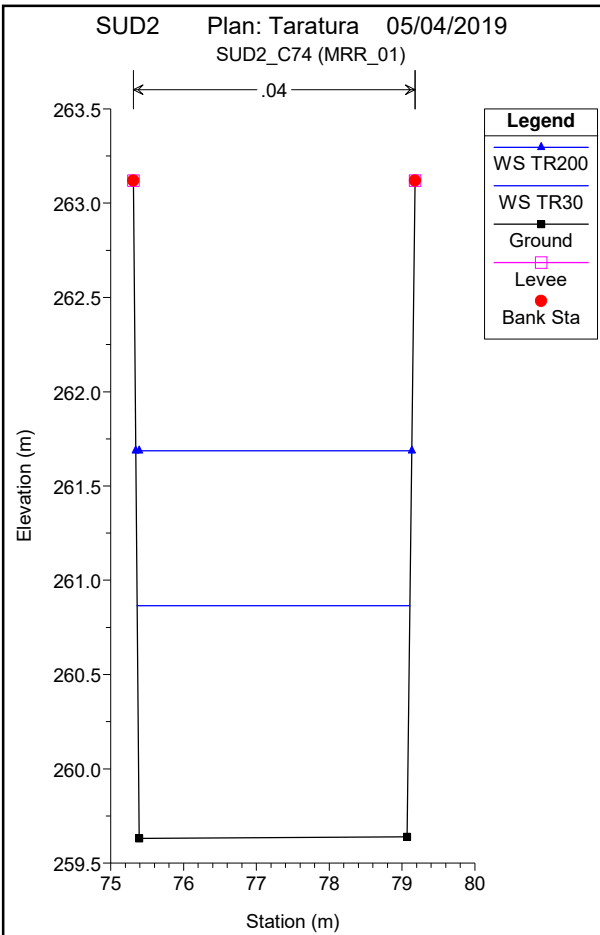

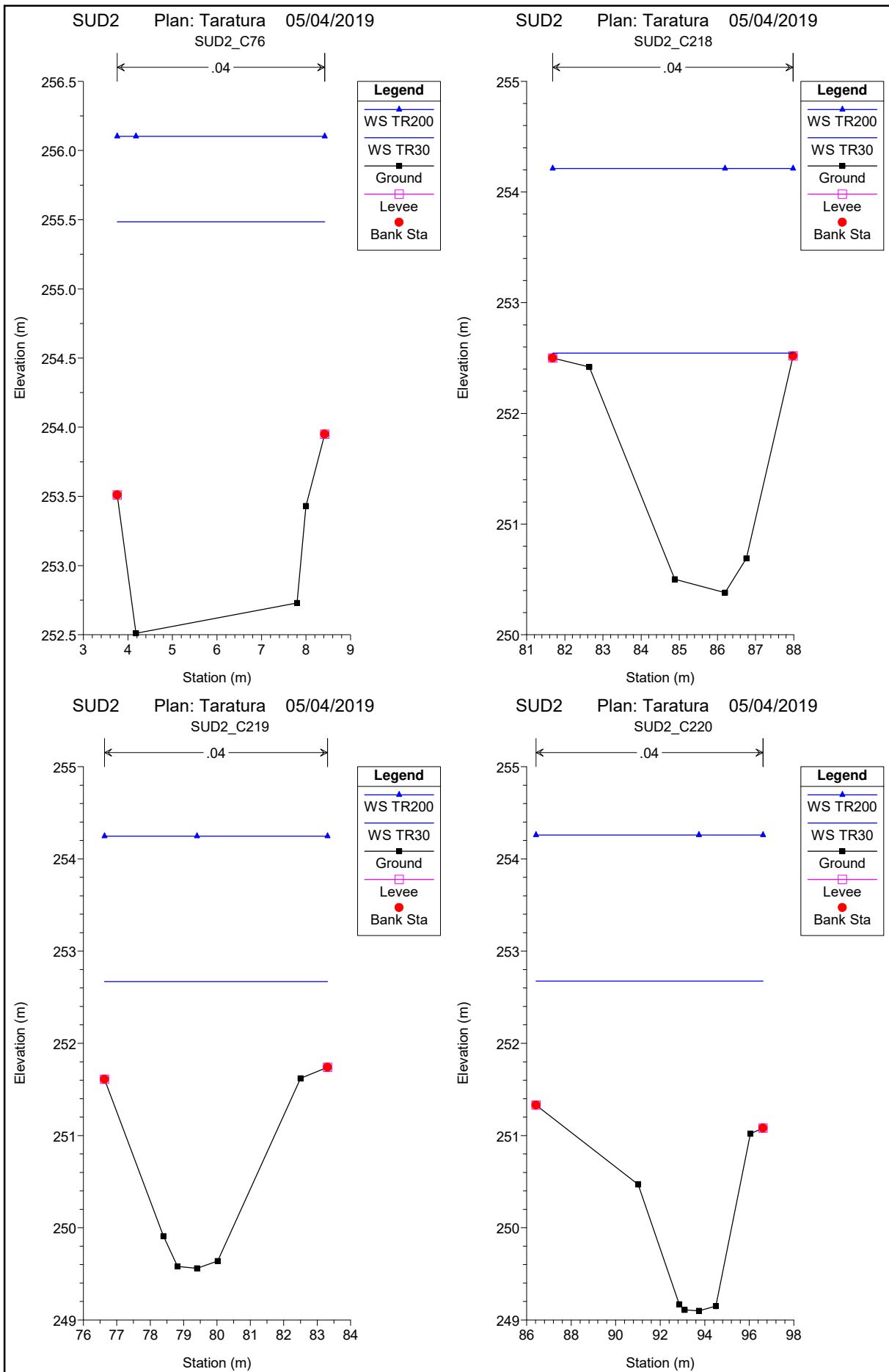

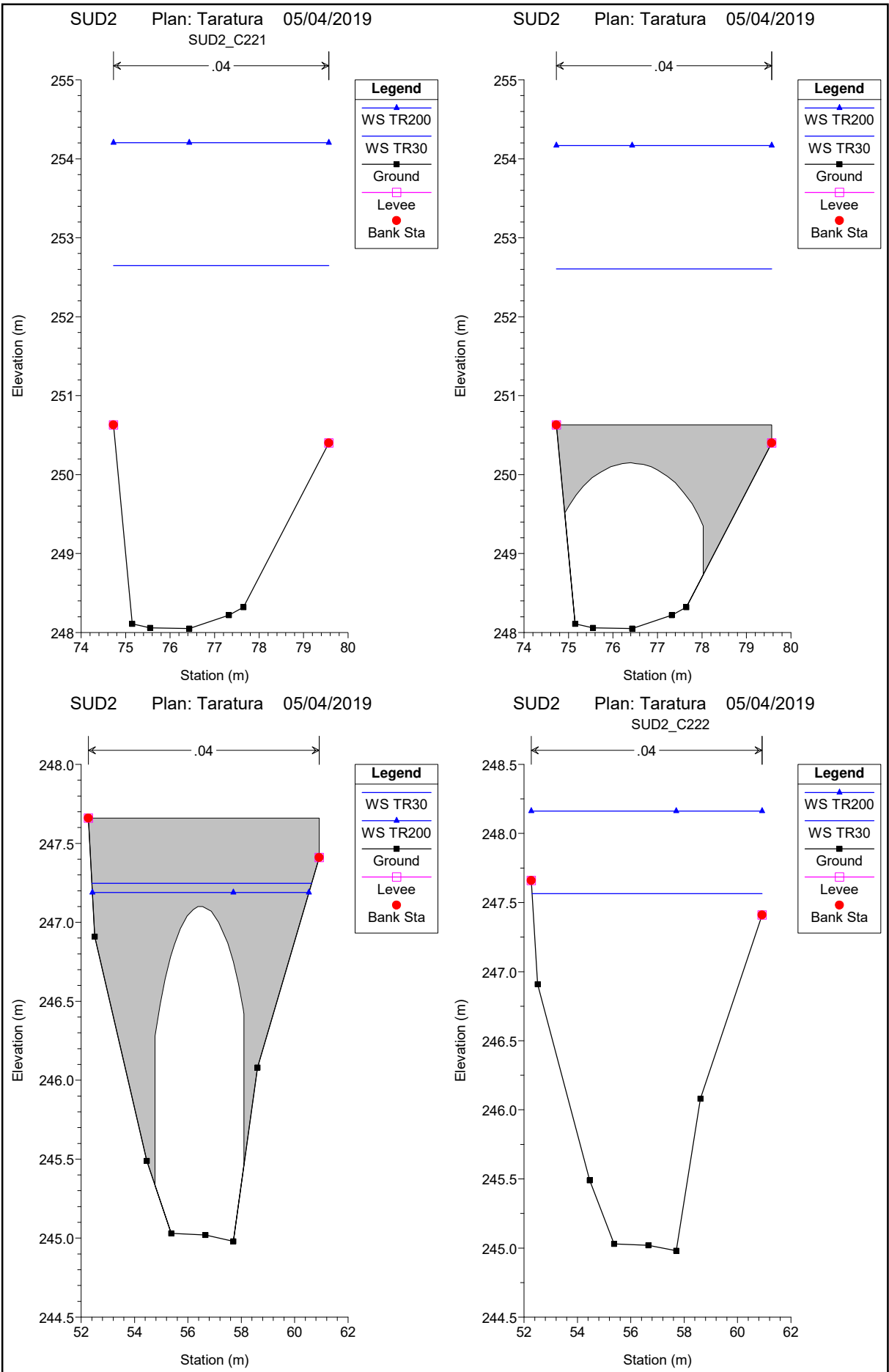

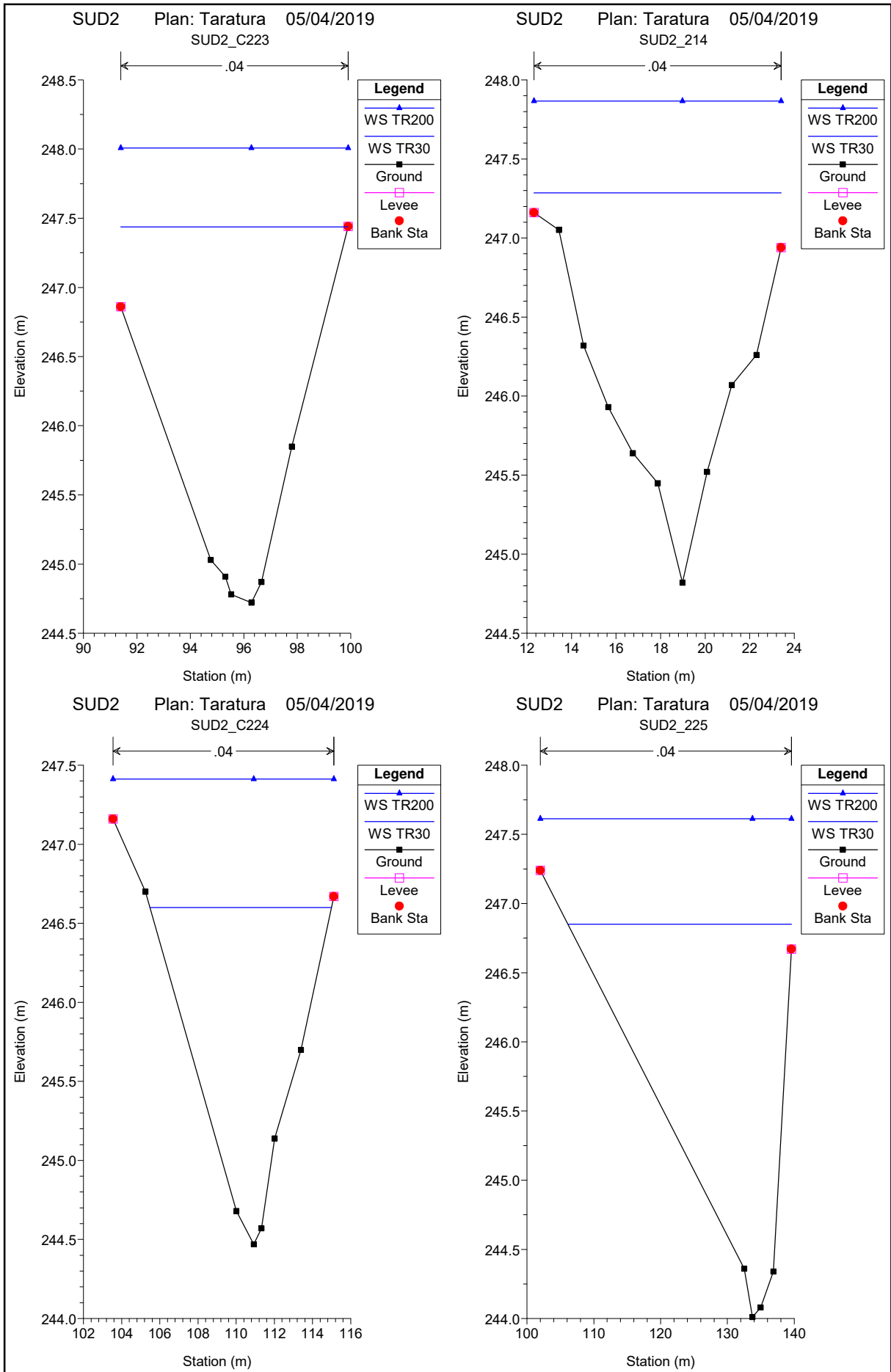

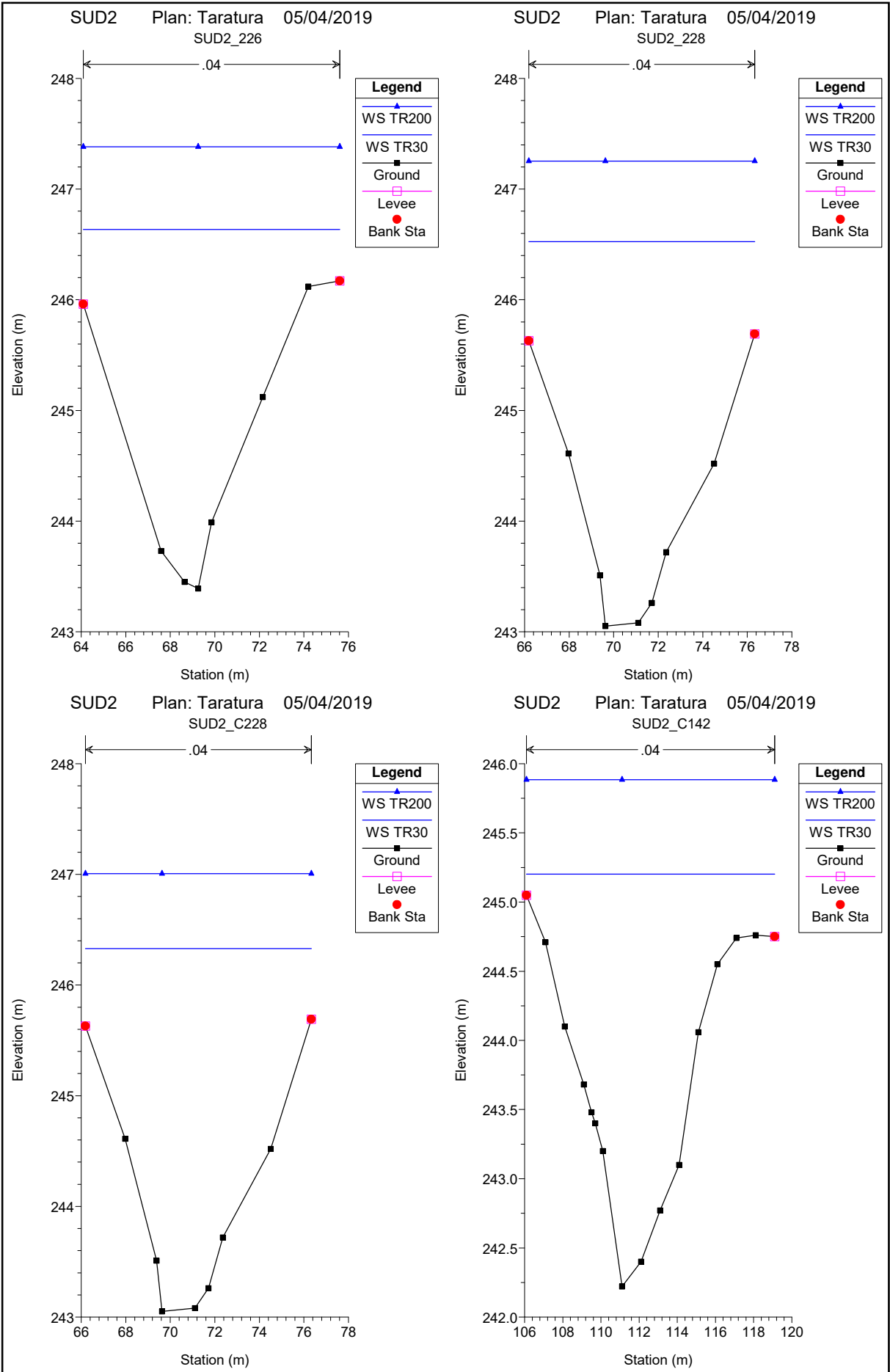

SUD2 Plan: Taratura 05/04/2019
SUD2_C143

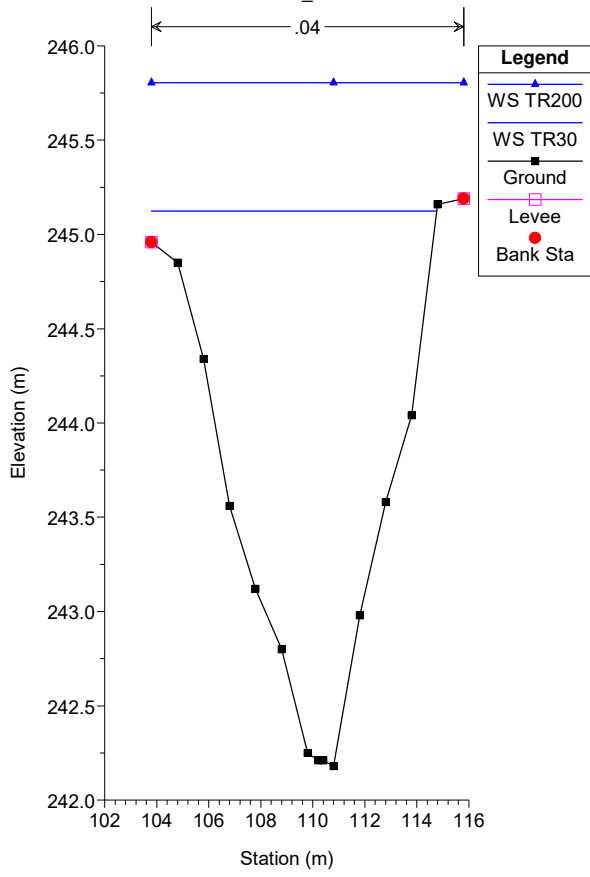

SUD2 Plan: Taratura 05/04/2019
SUD2_C216

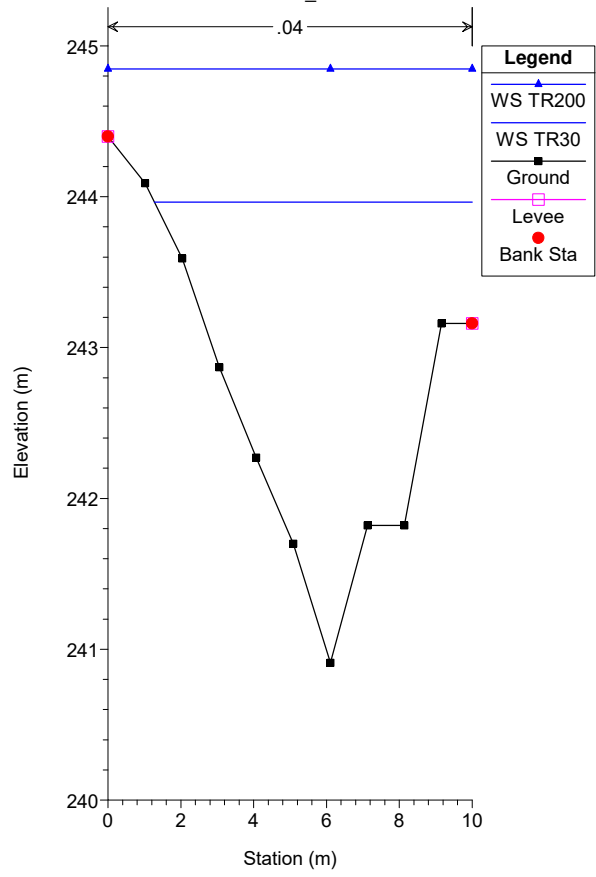

SUD2 Plan: Taratura 05/04/2019

FOSSO_RIOLO FOSSO_RIOLO1

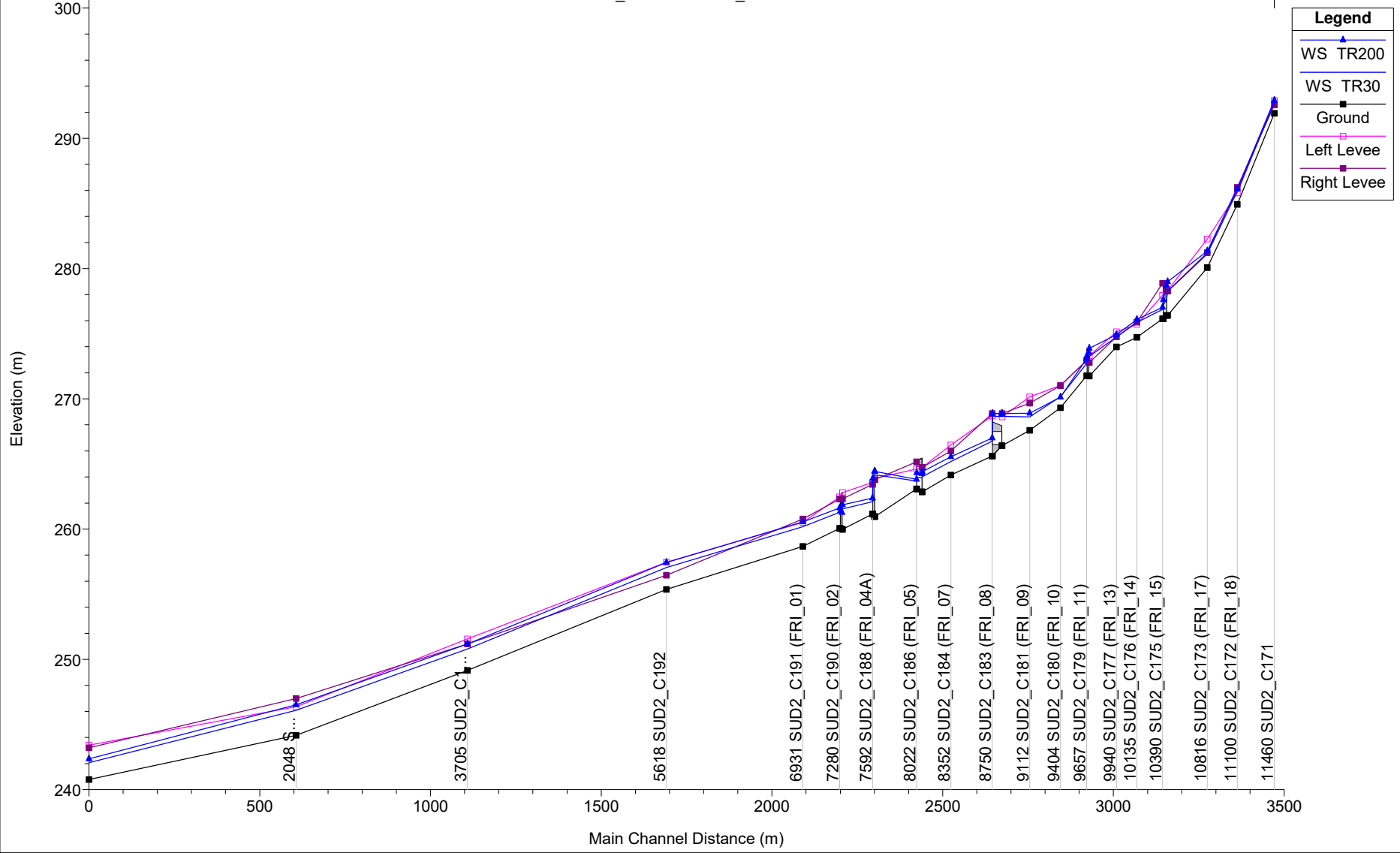

SUD2 Plan: Taratura 05/04/2019

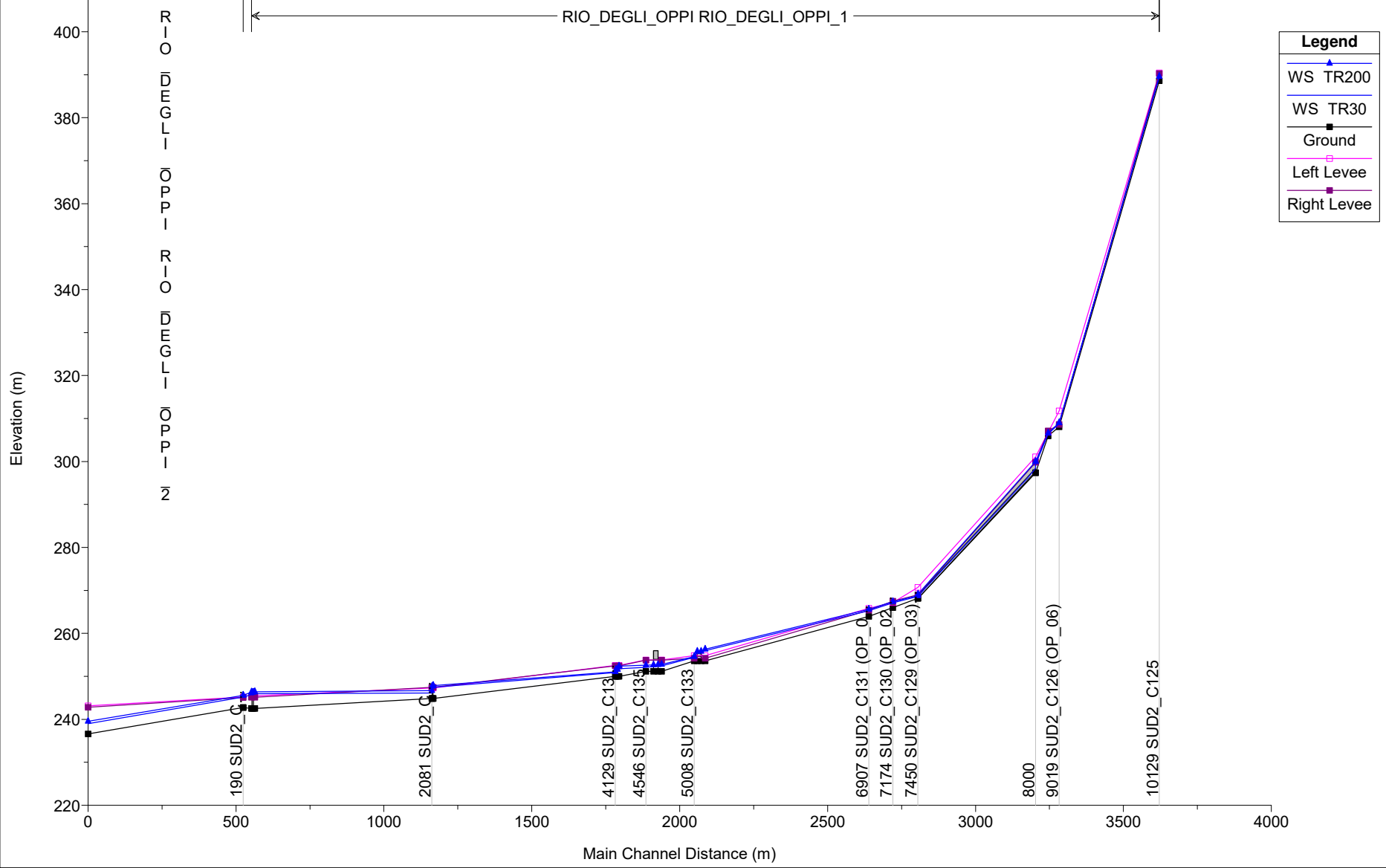

SUD2 Plan: Taratura 05/04/2019

FOSSO_POLICIANO FOSSO_POLICIANO1

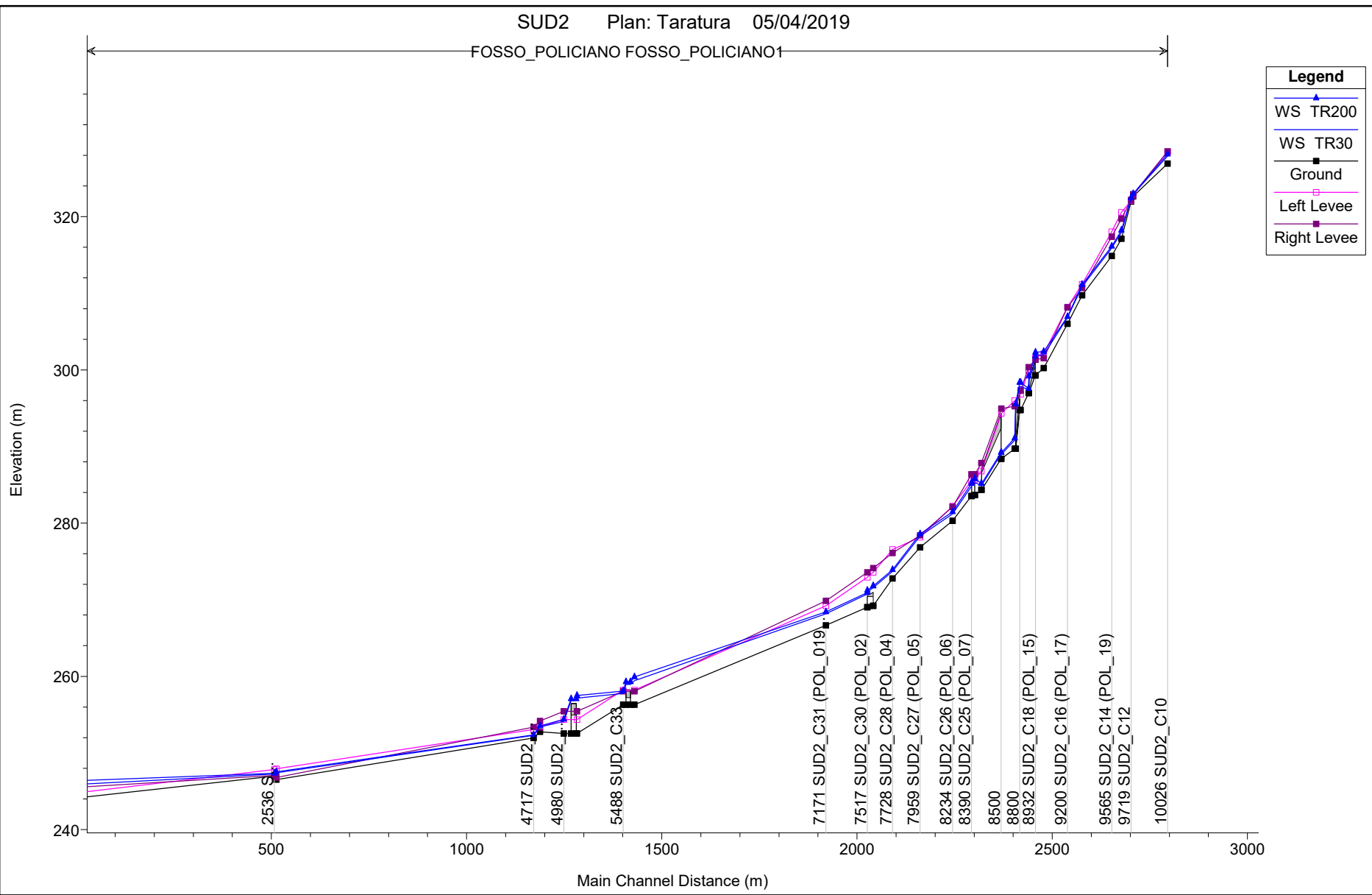

Legend

- WS TR200
- WS TR30
- Ground
- Left Levee
- Right Levee

SUD2 Plan: Taratura 05/04/2019

RIO_DEL_CHIO RIO_DEL_CHIO1

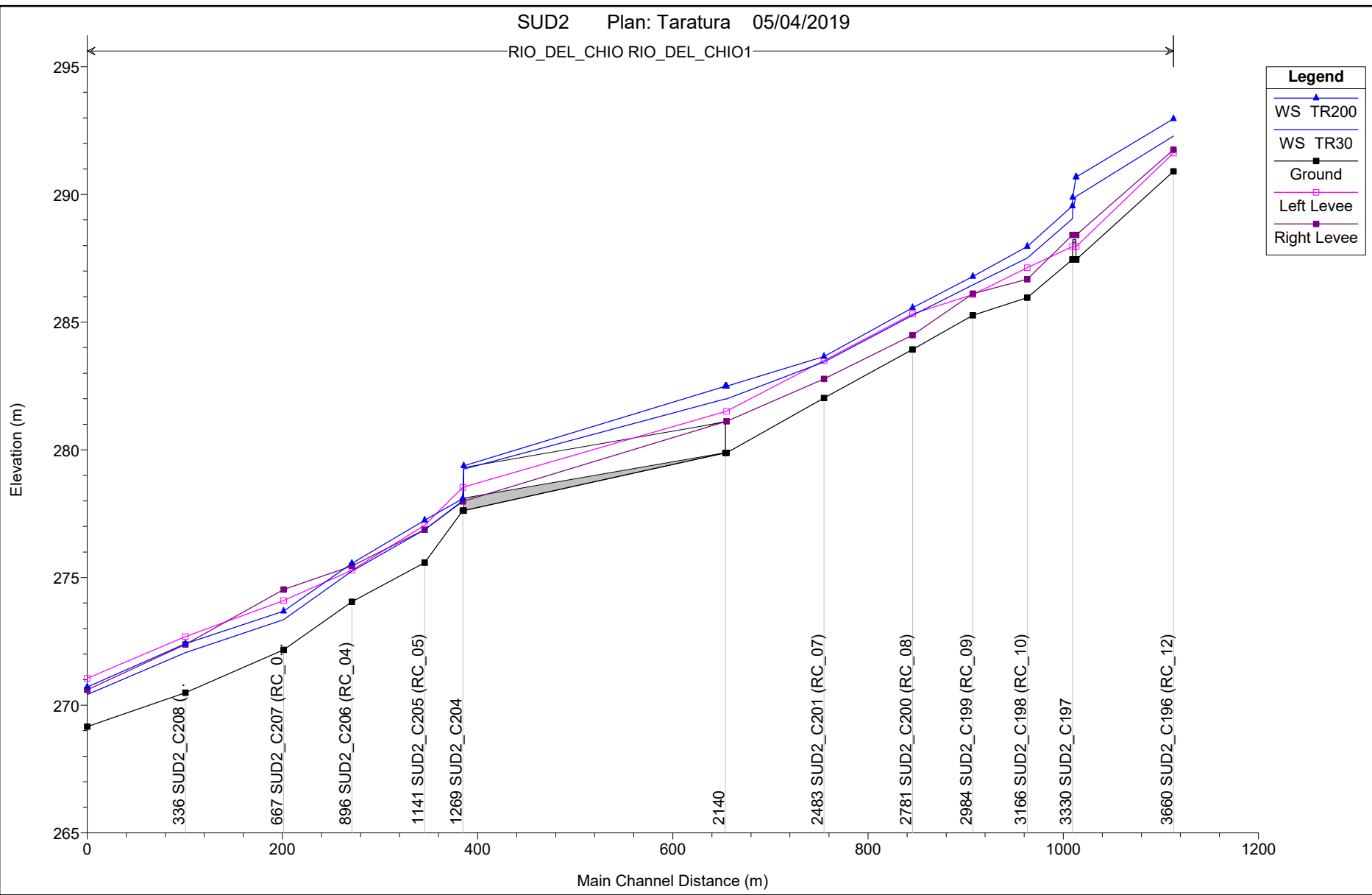

Legend

- WS TR200
- WS TR30
- Ground
- Left Levee
- Right Levee

SUD2 Plan: Taratura 05/04/2019

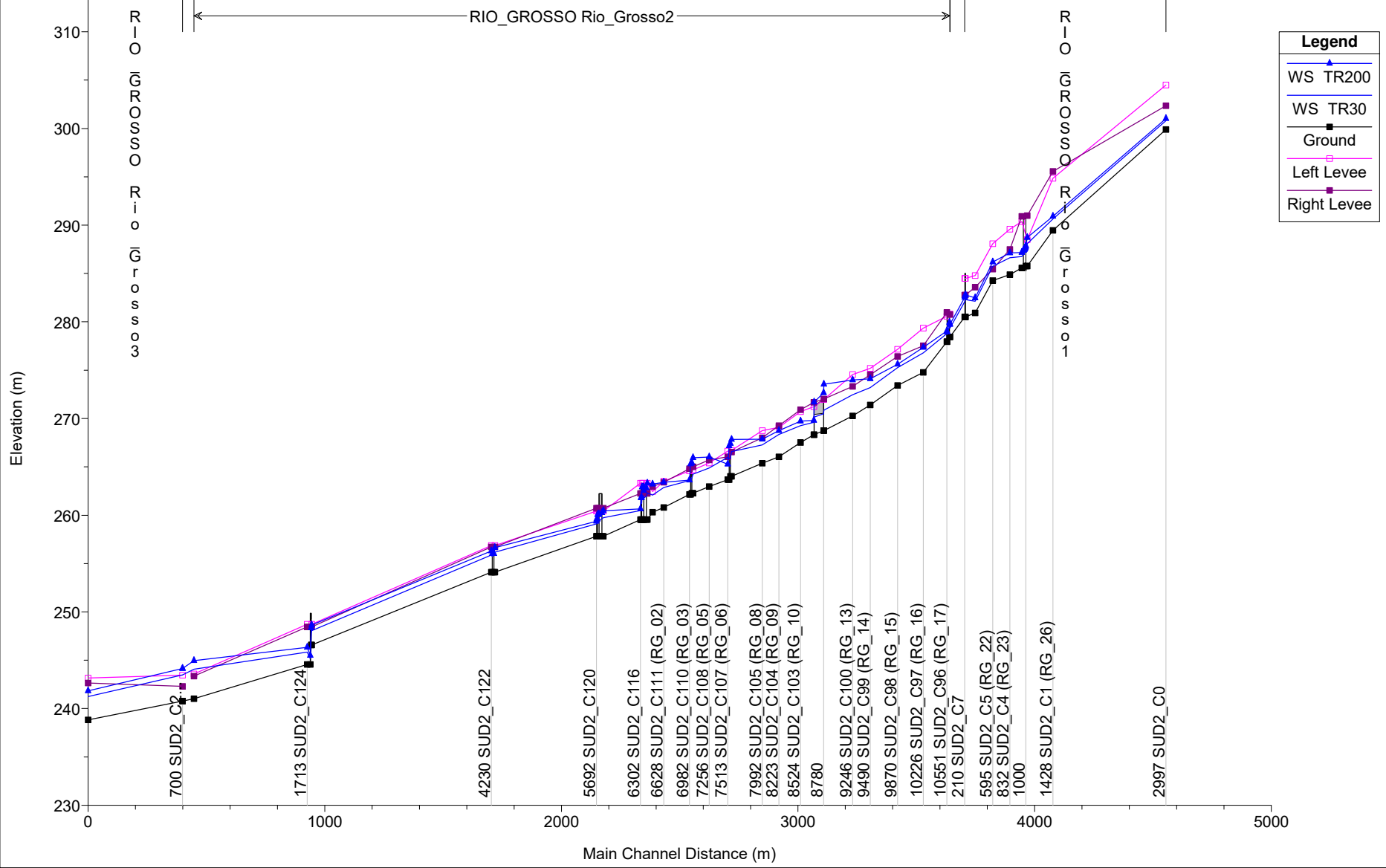

SUD2 Plan: Taratura 05/04/2019

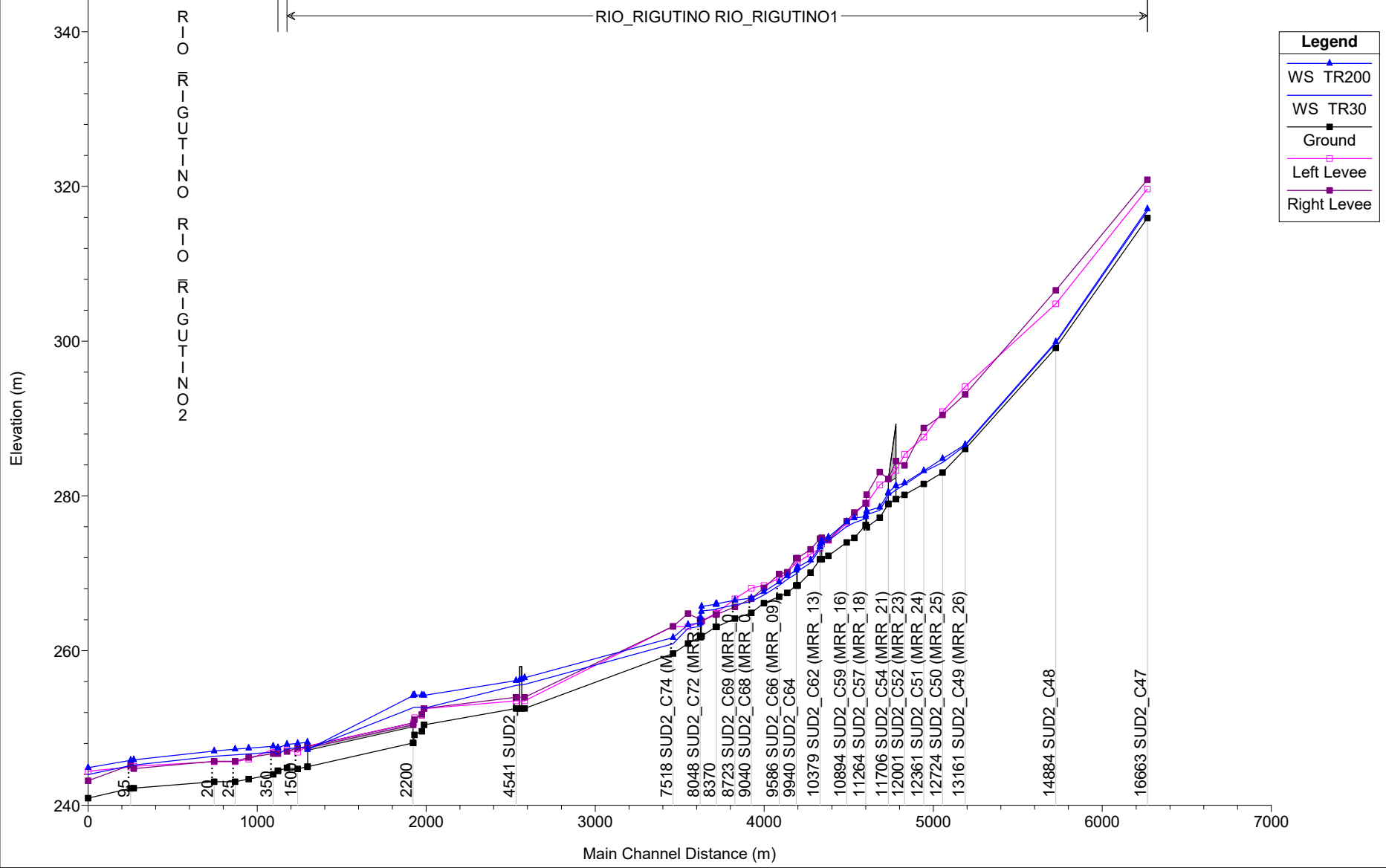

SUD2 Plan: Taratura 05/04/2019

RIO_DI_VITIANO RIO_DI_VITIANO1

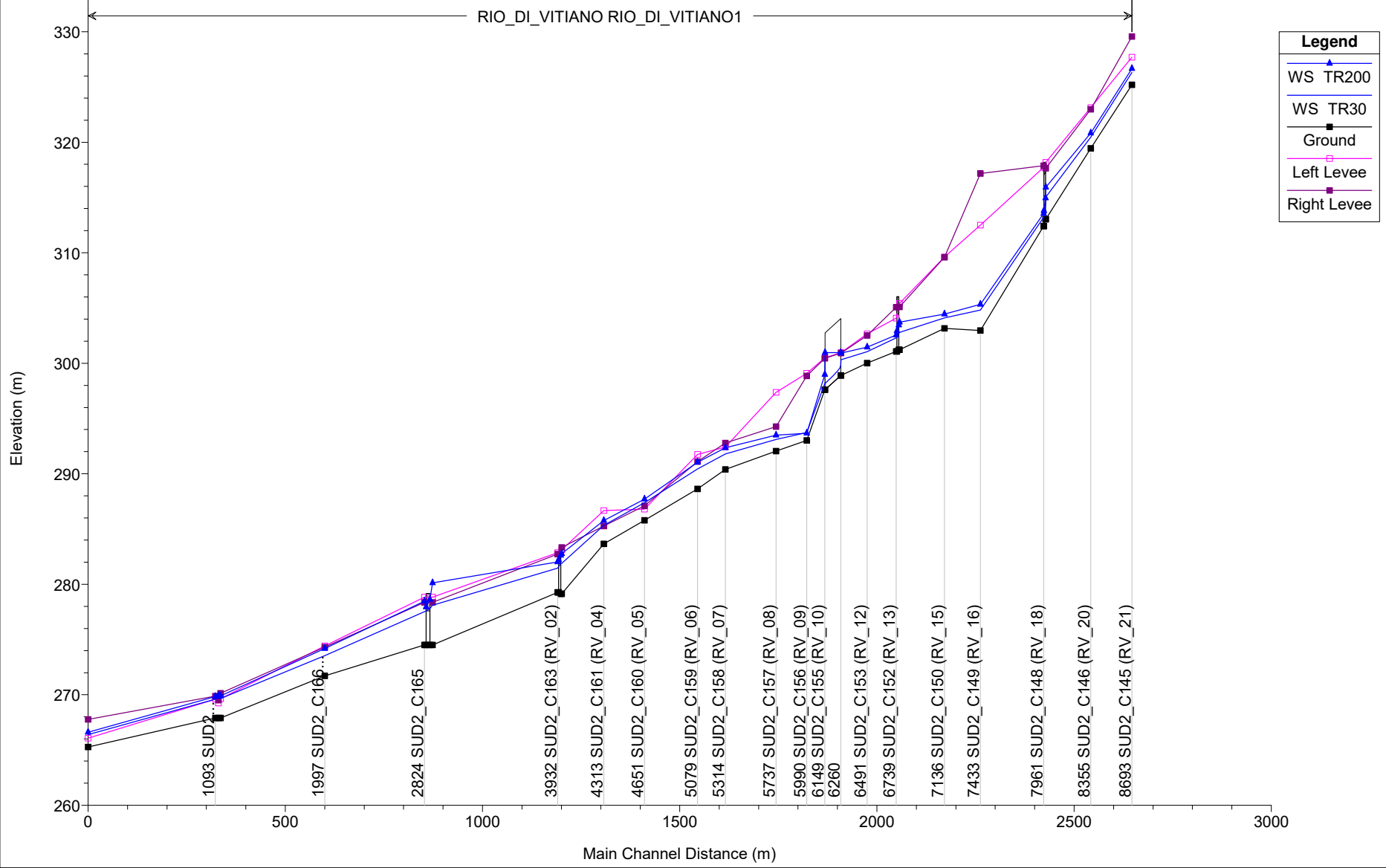

Legend

- WS TR200 (Blue line with triangles)
- WS TR30 (Blue line with squares)
- Ground (Black line with squares)
- Left Levee (Magenta line with squares)
- Right Levee (Magenta line with squares)

HEC-RAS Plan: Taratura (Continued)

River	Reach	River Sta	Profile	Q Total (m3/s)	Min Ch El (m)	W.S. Elev (m)	Crit W.S. (m)	E.G. Elev (m)	E.G. Slope (m/m)	Vel Chnl (m/s)	Flow Area (m2)	Top Width (m)	Froude # Chl
RIO_GROSSO	Rio_Grosso2	10226	TR30	18.55	274.77	276.80	276.57	277.15	0.012187	2.62	7.08	6.14	0.78
RIO_GROSSO	Rio_Grosso2	10226	TR200	30.90	274.77	277.37	277.06	277.77	0.010510	2.80	11.02	7.76	0.75
RIO_GROSSO	Rio_Grosso2	9870	TR30	18.55	273.42	275.26	275.14	275.67	0.015309	2.82	6.58	6.10	0.87
RIO_GROSSO	Rio_Grosso2	9870	TR200	30.90	273.42	275.60	275.60	276.23	0.019469	3.51	8.80	7.02	1.00
RIO_GROSSO	Rio_Grosso2	9490	TR30	18.55	271.39	273.21	273.17	273.69	0.019095	3.07	6.05	5.82	0.96
RIO_GROSSO	Rio_Grosso2	9490	TR200	30.90	271.39	274.10	273.64	274.42	0.007841	2.48	12.44	8.49	0.66
RIO_GROSSO	Rio_Grosso2	9246	TR30	18.55	270.28	272.47	272.01	272.73	0.008193	2.29	8.10	6.18	0.64
RIO_GROSSO	Rio_Grosso2	9246	TR200	30.90	270.28	273.99	272.54	274.10	0.001919	1.50	20.60	9.68	0.33
RIO_GROSSO	Rio_Grosso2	8845	TR30	18.55	268.75	270.86	270.44	271.33	0.016818	3.02	6.15	3.25	0.70
RIO_GROSSO	Rio_Grosso2	8845	TR200	30.90	268.75	273.54	271.08	273.74	0.004666	2.00	15.46	3.54	0.31
RIO_GROSSO	Rio_Grosso2	8780		Bridge									
RIO_GROSSO	Rio_Grosso2	8707	TR30	18.55	268.33	269.62	270.00	270.85	0.063952	4.93	3.77	4.50	1.72
RIO_GROSSO	Rio_Grosso2	8707	TR200	30.90	268.33	269.80	270.49	272.08	0.100255	6.69	4.62	4.74	2.16
RIO_GROSSO	Rio_Grosso2	8524	TR30	18.55	267.52	269.27	269.27	269.74	0.020587	3.04	6.10	6.51	1.00
RIO_GROSSO	Rio_Grosso2	8524	TR200	30.90	267.52	269.73	269.70	270.27	0.017447	3.25	9.52	8.19	0.96
RIO_GROSSO	Rio_Grosso2	8223	TR30	19.70	266.05	268.36	267.97	268.59	0.007480	2.14	9.22	7.80	0.63
RIO_GROSSO	Rio_Grosso2	8223	TR200	32.70	266.05	268.76	268.40	269.10	0.008952	2.61	12.55	9.03	0.71
RIO_GROSSO	Rio_Grosso2	7992	TR30	19.70	265.38	267.26	267.26	267.76	0.020347	3.11	6.34	6.43	1.00
RIO_GROSSO	Rio_Grosso2	7992	TR200	32.70	265.38	267.87	267.70	268.34	0.013249	3.02	10.83	8.36	0.85
RIO_GROSSO	Rio_Grosso2	7568	TR30	19.70	264.03	266.58	265.56	266.67	0.001932	1.29	15.23	9.58	0.33
RIO_GROSSO	Rio_Grosso2	7568	TR200	32.70	264.03	267.83	265.95	267.90	0.000990	1.20	27.24	9.65	0.23
RIO_GROSSO	Rio_Grosso2	7520		Bridge									
RIO_GROSSO	Rio_Grosso2	7513	TR30	19.70	263.69	266.00	265.46	266.16	0.004832	1.78	11.09	9.31	0.52
RIO_GROSSO	Rio_Grosso2	7513	TR200	32.70	263.69	265.28	265.87	267.17	0.094647	6.09	5.37	6.57	2.15
RIO_GROSSO	Rio_Grosso2	7256	TR30	19.70	262.96	264.88	264.88	265.42	0.022170	3.25	6.06	5.72	1.01
RIO_GROSSO	Rio_Grosso2	7256	TR200	32.70	262.96	266.03	265.44	266.21	0.004455	1.87	17.44	11.82	0.49
RIO_GROSSO	Rio_Grosso2	7039	TR30	19.70	262.28	264.25	263.85	264.49	0.007093	2.14	9.19	7.64	0.62
RIO_GROSSO	Rio_Grosso2	7039	TR200	32.70	262.28	265.94	264.29	266.03	0.001259	1.34	24.47	9.37	0.26
RIO_GROSSO	Rio_Grosso2	7000		Bridge									
RIO_GROSSO	Rio_Grosso2	6982	TR30	19.70	262.15	263.57	263.71	264.21	0.028926	3.56	5.54	6.34	1.22
RIO_GROSSO	Rio_Grosso2	6982	TR200	32.70	262.15	263.62	264.13	265.21	0.068455	5.58	5.85	6.50	1.88
RIO_GROSSO	Rio_Grosso2	6628	TR30	19.70	260.81	262.87	262.51	263.11	0.007494	2.17	9.06	7.86	0.65
RIO_GROSSO	Rio_Grosso2	6628	TR200	32.70	260.81	263.41	262.94	263.70	0.006725	2.38	13.76	9.59	0.63
RIO_GROSSO	Rio_Grosso2	6470	TR30	19.70	260.31	262.08	262.08	262.55	0.019240	3.02	6.52	6.96	1.00
RIO_GROSSO	Rio_Grosso2	6470	TR200	32.70	260.31	263.21	262.50	263.42	0.004279	2.05	15.98	8.94	0.49
RIO_GROSSO	Rio_Grosso2	6399	TR30	19.70	259.55	262.31	260.89	262.34	0.000628	0.78	25.38	16.30	0.20
RIO_GROSSO	Rio_Grosso2	6399	TR200	32.70	259.55	263.32	261.23	263.35	0.000371	0.78	42.09	16.79	0.16
RIO_GROSSO	Rio_Grosso2	6370		Bridge									
RIO_GROSSO	Rio_Grosso2	6341	TR30	19.70	259.55	262.00	260.89	262.05	0.001117	0.96	20.57	14.93	0.26
RIO_GROSSO	Rio_Grosso2	6341	TR200	32.70	259.55	262.92	261.23	262.97	0.000617	0.92	35.55	16.60	0.20
RIO_GROSSO	Rio_Grosso2	6327	TR30	19.70	259.55	261.99	260.89	262.04	0.001135	0.96	20.45	14.89	0.26
RIO_GROSSO	Rio_Grosso2	6327	TR200	32.70	259.55	262.92	261.23	262.96	0.000621	0.92	35.48	16.60	0.20
RIO_GROSSO	Rio_Grosso2	6315		Bridge									
RIO_GROSSO	Rio_Grosso2	6302	TR30	19.70	259.55	260.48	260.89	261.81	0.107144	5.11	3.85	7.06	2.21
RIO_GROSSO	Rio_Grosso2	6302	TR200	32.70	259.55	260.66	261.23	262.66	0.127293	6.26	5.22	8.00	2.48
RIO_GROSSO	Rio_Grosso2	5794	TR30	19.70	257.82	259.75	259.13	259.94	0.005085	1.93	10.20	6.93	0.51
RIO_GROSSO	Rio_Grosso2	5794	TR200	32.70	257.82	260.45	259.57	260.68	0.004524	2.11	15.53	8.10	0.49
RIO_GROSSO	Rio_Grosso2	5761		Bridge									
RIO_GROSSO	Rio_Grosso2	5727	TR30	20.15	257.82	259.47	259.15	259.77	0.009108	2.41	8.37	6.46	0.68
RIO_GROSSO	Rio_Grosso2	5727	TR200	33.35	257.82	260.14	259.58	260.47	0.007540	2.56	13.04	7.61	0.62
RIO_GROSSO	Rio_Grosso2	5709	TR30	20.15	257.82	259.34	259.15	259.71	0.012112	2.67	7.54	6.23	0.78
RIO_GROSSO	Rio_Grosso2	5709	TR200	33.35	257.82	260.06	259.58	260.43	0.008515	2.68	12.46	7.48	0.66
RIO_GROSSO	Rio_Grosso2	5701		Bridge									
RIO_GROSSO	Rio_Grosso2	5692	TR30	20.15	257.82	259.11	259.15	259.67	0.022597	3.31	6.09	6.14	1.06
RIO_GROSSO	Rio_Grosso2	5692	TR200	33.35	257.82	259.38	259.58	260.32	0.030607	4.30	7.76	6.29	1.24
RIO_GROSSO	Rio_Grosso2	4279	TR30	20.15	254.10	256.16	255.58	256.23	0.002565	1.17	17.26	18.74	0.39
RIO_GROSSO	Rio_Grosso2	4279	TR200	33.35	254.10	256.63	255.86	256.71	0.002104	1.23	27.10	23.45	0.37
RIO_GROSSO	Rio_Grosso2	4255		Bridge									
RIO_GROSSO	Rio_Grosso2	4230	TR30	20.15	254.10	255.87	255.57	256.01	0.006397	1.65	12.24	15.73	0.60
RIO_GROSSO	Rio_Grosso2	4230	TR200	33.35	254.10	256.29	255.86	256.44	0.004899	1.69	19.77	20.09	0.54
RIO_GROSSO	Rio_Grosso2	1745	TR30	20.60	246.57	248.06	247.84	248.52	0.016704	3.02	6.83	4.59	0.79
RIO_GROSSO	Rio_Grosso2	1745	TR200	34.00	246.57	248.64	248.35	249.29	0.023767	3.58	9.50	4.59	0.79
RIO_GROSSO	Rio_Grosso2	1729		Bridge									
RIO_GROSSO	Rio_Grosso2	1713	TR30	20.60	244.57	245.84	245.84	246.48	0.025887	3.52	5.85	4.59	1.00
RIO_GROSSO	Rio_Grosso2	1713	TR200	34.00	244.57	246.35	246.35	247.23	0.027774	4.17	8.15	4.59	1.00

HEC-RAS Plan: Taratura (Continued)

River	Reach	River Sta	Profile	Q Total (m3/s)	Min Ch El (m)	W.S. Elev (m)	Crit W.S. (m)	E.G. Elev (m)	E.G. Slope (m/m)	Vel Chnl (m/s)	Flow Area (m2)	Top Width (m)	Froude # Chl
RIO_DEL_CHIO	RIO_DEL_CHIO1	3332	TR30	5.20	287.45	289.92	289.05	290.13	0.016978	2.00	2.60	1.25	0.44
RIO_DEL_CHIO	RIO_DEL_CHIO1	3332	TR200	8.70	287.45	290.69	289.55	290.99	0.023345	2.45	3.56	1.25	0.46
RIO_DEL_CHIO	RIO_DEL_CHIO1	3331											
RIO_DEL_CHIO	RIO_DEL_CHIO1	3330	TR30	5.20	287.45	289.05	289.05	289.65	0.061540	3.44	1.51	1.25	1.00
RIO_DEL_CHIO	RIO_DEL_CHIO1	3330	TR200	8.70	287.45	289.55	289.55	290.40	0.075518	4.08	2.13	1.25	1.00
RIO_DEL_CHIO	RIO_DEL_CHIO1	3166	TR30	5.20	285.96	287.51	287.13	287.65	0.008171	1.67	3.11	2.93	0.52
RIO_DEL_CHIO	RIO_DEL_CHIO1	3166	TR200	8.70	285.96	287.96	287.41	288.16	0.008707	1.96	4.45	2.93	0.51
RIO_DEL_CHIO	RIO_DEL_CHIO1	2984	TR30	5.20	285.27	286.46	286.46	286.83	0.031217	2.69	1.93	2.59	1.00
RIO_DEL_CHIO	RIO_DEL_CHIO1	2984	TR200	8.70	285.27	286.79	286.76	287.29	0.032047	3.14	2.77	2.59	0.97
RIO_DEL_CHIO	RIO_DEL_CHIO1	2781	TR30	5.20	283.93	285.27	285.08	285.48	0.014077	2.00	2.59	3.27	0.72
RIO_DEL_CHIO	RIO_DEL_CHIO1	2781	TR200	8.70	283.93	285.56	285.38	285.87	0.016055	2.43	3.57	3.36	0.75
RIO_DEL_CHIO	RIO_DEL_CHIO1	2483	TR30	5.20	282.03	283.44	283.44	283.69	0.029155	2.23	2.34	4.62	1.00
RIO_DEL_CHIO	RIO_DEL_CHIO1	2483	TR200	8.70	282.03	283.65	283.65	283.98	0.027827	2.54	3.42	5.23	1.00
RIO_DEL_CHIO	RIO_DEL_CHIO1	2155	TR30	5.20	279.88	281.99	281.01	282.05	0.002450	1.09	4.75	2.96	0.28
RIO_DEL_CHIO	RIO_DEL_CHIO1	2155	TR200	8.70	279.88	282.49	281.33	282.59	0.003453	1.40	6.23	2.96	0.31
RIO_DEL_CHIO	RIO_DEL_CHIO1	2140											
RIO_DEL_CHIO	RIO_DEL_CHIO1	1269	TR30	5.20	277.62	278.01	278.01	278.11	0.026780	1.44	3.61	17.21	1.00
RIO_DEL_CHIO	RIO_DEL_CHIO1	1269	TR200	8.70	277.62	278.09	278.09	278.24	0.023783	1.69	5.14	17.48	1.00
RIO_DEL_CHIO	RIO_DEL_CHIO1	1141	TR30	5.20	275.58	276.87	276.86	277.09	0.014974	2.09	2.49	3.08	0.74
RIO_DEL_CHIO	RIO_DEL_CHIO1	1141	TR200	8.70	275.58	277.24	277.01	277.52	0.014245	2.34	3.72	3.42	0.71
RIO_DEL_CHIO	RIO_DEL_CHIO1	896	TR30	5.20	274.05	275.24	275.24	275.61	0.027036	2.68	1.94	2.63	1.00
RIO_DEL_CHIO	RIO_DEL_CHIO1	896	TR200	8.70	274.05	275.55	275.55	276.05	0.028007	3.11	2.80	2.82	1.00
RIO_DEL_CHIO	RIO_DEL_CHIO1	667	TR30	5.20	272.17	273.35	273.20	273.55	0.013093	1.97	2.63	3.64	0.74
RIO_DEL_CHIO	RIO_DEL_CHIO1	667	TR200	8.70	272.17	273.68	273.47	273.93	0.011949	2.21	3.94	4.12	0.72
RIO_DEL_CHIO	RIO_DEL_CHIO1	336	TR30	5.20	270.49	272.06	271.80	272.25	0.012648	1.96	2.66	3.06	0.67
RIO_DEL_CHIO	RIO_DEL_CHIO1	336	TR200	8.70	270.49	272.41	272.14	272.67	0.013254	2.26	3.85	3.68	0.71
RIO_DEL_CHIO	RIO_DEL_CHIO1	6	TR30	5.20	269.16	270.41	270.35	270.68	0.019522	2.29	2.27	3.26	0.88
RIO_DEL_CHIO	RIO_DEL_CHIO1	6	TR200	8.70	269.16	270.71	270.64	271.06	0.019517	2.62	3.32	3.85	0.90
RIO_DEGLI_OPPI	RIO_DEGLI_OPPI_1	10129	TR30	1.30	388.59	389.44	389.47	389.69	0.047655	2.25	0.58	1.37	1.11
RIO_DEGLI_OPPI	RIO_DEGLI_OPPI_1	10129	TR200	2.20	388.59	389.62	389.67	389.96	0.047575	2.57	0.86	1.66	1.14
RIO_DEGLI_OPPI	RIO_DEGLI_OPPI_1	9019	TR30	1.30	308.05	308.78	308.78	309.00	0.035626	2.05	0.63	1.47	1.00
RIO_DEGLI_OPPI	RIO_DEGLI_OPPI_1	9019	TR200	2.20	308.05	308.98	308.98	309.25	0.035163	2.33	0.95	1.70	1.00
RIO_DEGLI_OPPI	RIO_DEGLI_OPPI_1	8897	TR30	1.30	305.98	306.45	306.59	306.91	0.102888	3.01	0.43	1.59	1.84
RIO_DEGLI_OPPI	RIO_DEGLI_OPPI_1	8897	TR200	2.20	305.98	306.57	306.76	307.17	0.103572	3.44	0.64	1.92	1.90
RIO_DEGLI_OPPI	RIO_DEGLI_OPPI_1	8758	TR30	1.30	297.38	299.30	298.03	299.30	0.000138	0.24	5.47	5.94	0.08
RIO_DEGLI_OPPI	RIO_DEGLI_OPPI_1	8758	TR200	2.20	297.38	299.96	298.23	299.96	0.000075	0.22	10.06	7.88	0.06
RIO_DEGLI_OPPI	RIO_DEGLI_OPPI_1	8000											
RIO_DEGLI_OPPI	RIO_DEGLI_OPPI_1	7450	TR30	1.30	268.14	268.59	268.59	268.76	0.028571	1.84	0.71	2.06	1.00
RIO_DEGLI_OPPI	RIO_DEGLI_OPPI_1	7450	TR200	2.20	268.14	268.74	268.74	268.97	0.027328	2.11	1.04	2.28	1.00
RIO_DEGLI_OPPI	RIO_DEGLI_OPPI_1	7174	TR30	1.30	265.99	267.10	266.56	267.13	0.003928	0.78	1.67	3.53	0.36
RIO_DEGLI_OPPI	RIO_DEGLI_OPPI_1	7174	TR200	2.20	265.99	267.37	266.76	267.40	0.003095	0.69	3.19	7.63	0.34
RIO_DEGLI_OPPI	RIO_DEGLI_OPPI_1	6907	TR30	5.82	263.95	265.29	265.29	265.70	0.030026	2.84	2.05	2.50	1.00
RIO_DEGLI_OPPI	RIO_DEGLI_OPPI_1	6907	TR200	9.15	263.95	265.59	265.59	266.11	0.030271	3.19	2.87	2.79	1.00
RIO_DEGLI_OPPI	RIO_DEGLI_OPPI_1	5093	TR30	5.82	253.62	255.96	254.62	256.00	0.001275	0.87	6.72	3.34	0.20
RIO_DEGLI_OPPI	RIO_DEGLI_OPPI_1	5093	TR200	9.15	253.62	256.33	254.87	256.40	0.002064	1.15	7.93	3.34	0.24
RIO_DEGLI_OPPI	RIO_DEGLI_OPPI_1	5051											
RIO_DEGLI_OPPI	RIO_DEGLI_OPPI_1	5008	TR30	5.82	253.62	254.40	254.62	255.12	0.075991	3.76	1.55	3.13	1.71
RIO_DEGLI_OPPI	RIO_DEGLI_OPPI_1	5008	TR200	9.15	253.62	254.60	254.87	255.51	0.070638	4.23	2.16	3.23	1.65
RIO_DEGLI_OPPI	RIO_DEGLI_OPPI_1	4612	TR30	5.82	251.16	252.44	251.98	252.48	0.002254	0.91	6.42	9.13	0.35
RIO_DEGLI_OPPI	RIO_DEGLI_OPPI_1	4612	TR200	9.15	251.16	252.76	252.15	252.81	0.001800	0.95	9.62	10.74	0.32
RIO_DEGLI_OPPI	RIO_DEGLI_OPPI_1	4579											
RIO_DEGLI_OPPI	RIO_DEGLI_OPPI_1	4546	TR30	5.82	251.16	252.13	251.98	252.25	0.009127	1.51	3.87	7.35	0.66
RIO_DEGLI_OPPI	RIO_DEGLI_OPPI_1	4546	TR200	9.15	251.16	252.59	252.15	252.66	0.003207	1.17	7.81	9.86	0.42
RIO_DEGLI_OPPI	RIO_DEGLI_OPPI_1	4170	TR30	10.35	249.99	251.77	251.12	251.86	0.002995	1.28	8.07	7.50	0.39
RIO_DEGLI_OPPI	RIO_DEGLI_OPPI_1	4170	TR200	16.10	249.99	252.37	251.40	252.44	0.001994	1.23	13.10	9.45	0.33
RIO_DEGLI_OPPI	RIO_DEGLI_OPPI_1	4150											
RIO_DEGLI_OPPI	RIO_DEGLI_OPPI_1	4129	TR30	10.35	249.99	250.88	251.12	251.65	0.059178	3.89	2.66	4.56	1.63
RIO_DEGLI_OPPI	RIO_DEGLI_OPPI_1	4129	TR200	16.10	249.99	251.03	251.40	252.18	0.074971	4.76	3.38	5.05	1.86
RIO_DEGLI_OPPI	RIO_DEGLI_OPPI_1	2122	TR30	10.35	244.87	247.48	245.91	247.50	0.000361	0.58	17.81	11.66	0.15
RIO_DEGLI_OPPI	RIO_DEGLI_OPPI_1	2122	TR200	16.10	244.87	247.83	246.16	247.85	0.000472	0.74	21.86	11.66	0.17
RIO_DEGLI_OPPI	RIO_DEGLI_OPPI_1	2102											
RIO_DEGLI_OPPI	RIO_DEGLI_OPPI_1	2081	TR30	10.35	244.87	246.13	245.91	246.31	0.008766	1.91	5.41	6.71	0.68
RIO_DEGLI_OPPI	RIO_DEGLI_OPPI_1	2081	TR200	16.10	244.87	246.69	246.16	246.83	0.004297	1.66	9.67	8.49	0.50
RIO_DEGLI_OPPI	RIO_DEGLI_OPPI_1	122	TR30	10.35	242.55	245.95	243.70	245.96	0.000164	0.46	22.34	9.76	0.10
RIO_DEGLI_OPPI	RIO_DEGLI_OPPI_1	122	TR200	16.10	242.55	246.41	243.98	246.43	0.000236	0.60	26.83	9.76	0.12

HEC-RAS Plan: Taratura (Continued)

River	Reach	River Sta	Profile	Q Total (m3/s)	Min Ch El (m)	W.S. Elev (m)	Crit W.S. (m)	E.G. Elev (m)	E.G. Slope (m/m)	Vel Chnl (m/s)	Flow Area (m2)	Top Width (m)	Froude # Chl
FOSSO_POLICIANO	FOSSO_POLICIANO1	881	TR30	16.50	244.16	245.91	244.83	245.91	0.000073	0.26	69.30	85.37	0.07
FOSSO_POLICIANO	FOSSO_POLICIANO1	881	TR200	25.70	244.16	246.40	244.83	246.40	0.000050	0.26	114.70	94.36	0.06
FOSSO_POLICIANO	FOSSO_POLICIANO1	2	TR30	16.50	244.27	245.91	244.94	245.91	0.000096	0.29	76.87	94.58	0.08
FOSSO_POLICIANO	FOSSO_POLICIANO1	2	TR200	25.70	244.27	246.40	245.05	246.40	0.000051	0.25	122.90	94.58	0.06
AFF_RIGUTINO	AFF_RIGUTINO	1062	TR30	7.73	246.68	247.12	247.12	247.22	0.020828	1.45	5.94	29.44	0.92
AFF_RIGUTINO	AFF_RIGUTINO	1062	TR200	12.13	246.68	247.80	247.19	247.81	0.000438	0.50	25.90	29.44	0.17
AFF_RIGUTINO	AFF_RIGUTINO	158	TR30	7.73	245.74	247.11	246.29	247.11	0.000041	0.18	59.93	94.82	0.05
AFF_RIGUTINO	AFF_RIGUTINO	158	TR200	12.13	245.74	247.80	246.35	247.80	0.000010	0.12	129.32	101.53	0.03
AFF_RIGUTINO	AFF_RIGUTINO	106	TR30	7.73	245.49	247.11	246.46	247.11	0.000085	0.22	43.04	69.95	0.07
AFF_RIGUTINO	AFF_RIGUTINO	106	TR200	12.13	245.49	247.80	246.59	247.80	0.000019	0.15	97.13	81.58	0.04